

# Unleash the Power of COOL

## Seamless Integration, Cutting-Edge Features and Empowered Collaboration

Michael Meeks  
CEO

michael.meeks@collabora.com



"Stand at the crossroads and look; ask for the ancient paths, ask where the good way is, and walk in it, and you will find rest for your souls..." - Jeremiah 6:16



# **Collabora Online**

## Powerful Online Collaboration

# What is Collabora Online?

## Documents + Spreadsheets + Slides + Drawings

- Viewing and collaborative editing
- Feature rich

## Interoperability with Microsoft formats

- docx, doc, rtf, xlsx, xls, pptx, ppt

## Import filters and viewing for

- PDF, Visio, Publisher and many more

## Powerful WYSIWYG rendering

## On-premise integration

Architecture - a bet on CPU threads and network getting cheaper over time



# What is Collabora Online?

The screenshot displays the Collabora Online interface for editing a document titled "Sailing Yacht.odt". The top menu bar includes options like File, Home, Insert, Layout, References, Review, Format, Form, View, and Help. The ribbon below the menu contains various editing tools such as Paste, Bold, Italic, Underline, and text alignment options. The main editing area shows a document with a heading "Sailing yacht" and several paragraphs of text. A sidebar on the right contains a "Headings" panel with a tree view showing "Sailing yacht" and its sub-sections: "Etymology", "History", "Evolution of design", "Cruising yachts", and "Racing yachts". Below this is an "Images" panel with thumbnails for "Image3", "Image2", "Image1", and "Image4". A "Bookmarks" panel is also visible with entries like "firstHeading", "cite\_ref-Webster\_1-0", "cite\_ref-2", "cite\_ref-3", "cite\_ref--3\_4-0", "cite\_ref-Perry\_5-0", "cite\_ref-6", "Etymology", and "cite\_ref--1\_7-0". The bottom status bar shows "Page 1 of 3", "1,050 words, 6,614 characters", "Insert | Standard selection | English (UK) | Edit", and a search bar.

## Sailing yacht

A **sailing yacht** (US ship prefixes SY or S/Y), is a leisure craft that uses sails as its primary means of propulsion. A **yacht** may be a sail or power vessel used for pleasure, cruising, or racing.<sup>[1][2][3]</sup> There is no standard definition, so the term applies here to sailing vessels that have a cabin with amenities that accommodate overnight use. To be termed a "yacht", as opposed to a "boat", such a vessel is likely to be at least 33 feet (10 m) in length and have been judged to have good aesthetic qualities.<sup>[4]</sup> **Sailboats** that do not accommodate overnight use or are smaller than 30 feet (9.1 m) are not universally called yachts. Sailing yachts in excess of 130 feet (40 m) are generally considered to be **superyachts**.<sup>[5]</sup>

Sailing **yachts** are actively used in sport and are among categories recognized by the governing body of sailing sports, [World Sailing](#).<sup>[6]</sup>

### Etymology



Sailing yachts are actively used in sport and are among categories recognized by the governing body of sailing sports, [World Sailing](#).<sup>[6]</sup>

The term, *yacht*, originates from the [Dutch](#) word *jacht* (pl. *jachten*, which means "hunt"),

and originally referred to light, fast sailing vessels that the [Dutch Republic](#) navy used to pursue [pirates](#) and other transgressors around and into the shallow waters of the [Low Countries](#).<sup>[7]</sup>

### History

The history of pleasure boats begins with rowed craft in Pharaonic Egyptian times. The history of sailing yachts begins in Europe in the beginning of the 1600s with the building of a pleasure vessel for the son of [King James I of England](#). Pleasure vessels acquired the name *yacht* after the time of [Charles II](#), who spent time exiled in Europe and visited the Netherlands, where a variety of *jachten* were already well developed as pleasure boats for the elite classes since the beginning of the 17th century. Upon his restoration to the English crown, Charles commissioned a series of small yachts, which included at least one experimental [https://en.wikipedia.org/wiki/Charles\\_II\\_of\\_England](https://en.wikipedia.org/wiki/Charles_II_of_England) between two vessels occurred in 1661, followed by the first open sailing competition in 1663 in English waters.<sup>[8]</sup>





# Collaborative Spreadsheets

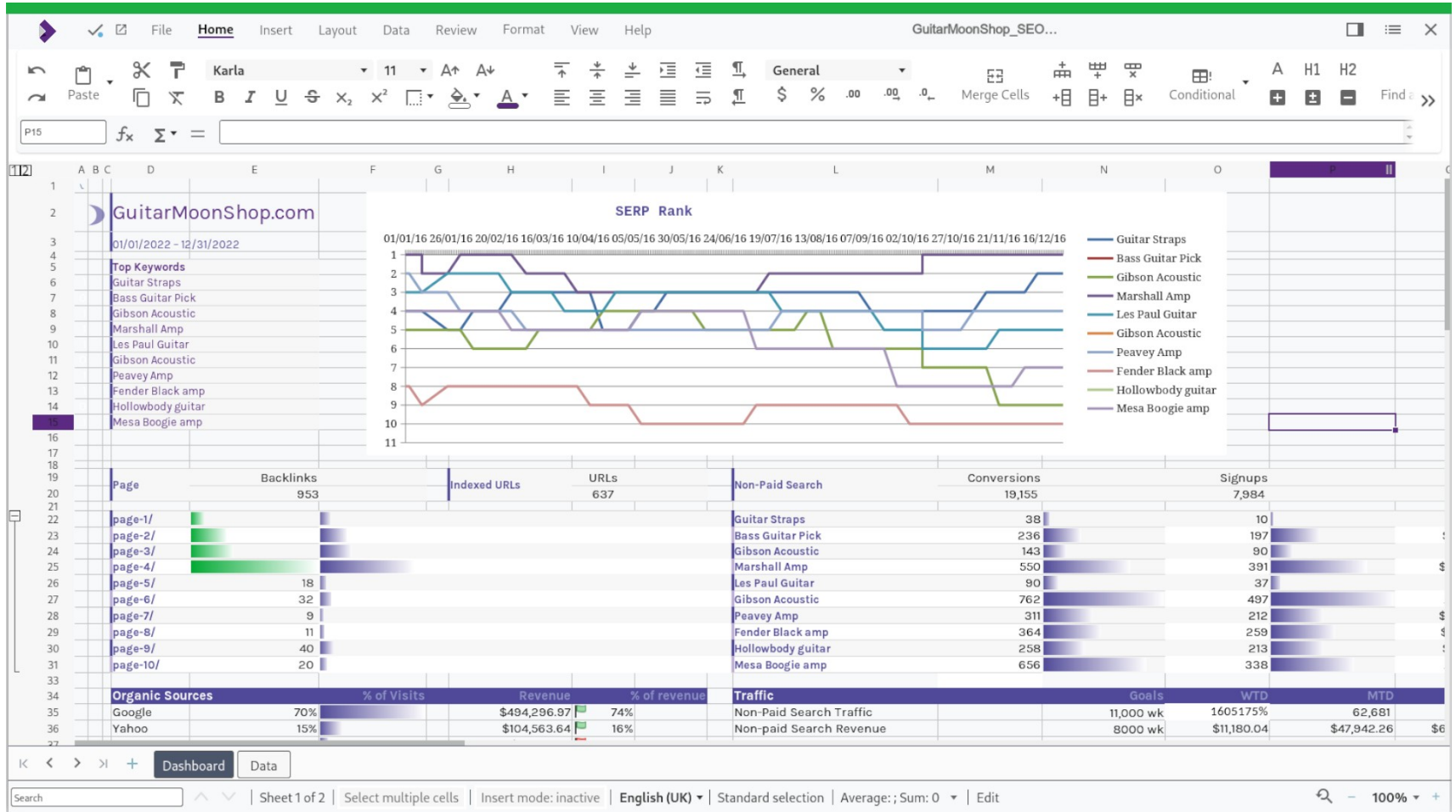

# Collaborative Drawing

Why-collabora-online-s...

File Home Insert Layout Review Format View Help

Liberation Serif 24 A+ A-

Collabora Online

## Why the Collabora Online Subscription?

Focused on providing high quality software, thoroughly tested and ready for business

Collabora Online is a powerful online office suite, which you can integrate into your own infrastructure. We take digital sovereignty seriously and provide you with all the tools to keep your data secure, without compromising on features. With our supported subscription you get:

- Assured Digital Sovereignty & Security**
  - On-premise / self hosted - control your data, app & network
  - No ties to any storage or authentication system
  - Documents are not broadcasted to all clients, but shared as pixels
  - Each document session gets its own private jail - with no local copy between document editing sessions
  - Simple integration based on a WOPI API providing storage & authentication
- No Limitations for Your Productivity**
  - All code is Open Source
  - Full featured, rapid improvement
  - Available for all major PC and mobile platforms
  - Flexible - many different integrations into 3<sup>rd</sup> party solutions
  - Excellent interoperability with DOCX, XLSX, PPTX and other Microsoft files
- A Cost Effective & Flexible Plan**
  - Simple pricing plan
  - High Availability as standard

Product Management Relationship

Page

Format: User

Orientation: Portrait

Background: None

Margin: Normal (1.90 cm)

Master Page: master-page3

Search

Page 1 of 1 | English (UK) | Edit

120%

# Collaborative Presentations

The screenshot displays the Collabora Online presentation editor interface. The main slide features the text "Collabora Productivity" and "Powerful Online Collaboration on Your Own Terms" on a purple background. The Collabora Online logo is visible in the bottom left corner of the slide. The interface includes a top menu bar with options like File, Home, Insert, Layout, Review, Format, View, and Help. A ribbon-style toolbar below the menu contains various editing tools such as Paste, Undo, Redo, Bold, Italic, Underline, Text, Text Box, Shapes, Image, and Connectors. On the left side, a slide navigation pane shows a list of slides, with the current slide highlighted. On the right side, a slide properties panel is open, showing settings for Format (Screen 16:9), Orientation (Landscape), Background (None), Master Slide (Title\_or\_Ending), and Layouts. The slide content area shows a stack of overlapping presentation slides, with red and green callouts indicating editing activity by "THOMAS" and "ANNE" respectively.

# Collabora for Android, iOS & Chromebooks

Also available  
on Desktop,  
Mobile &  
Chrome OS

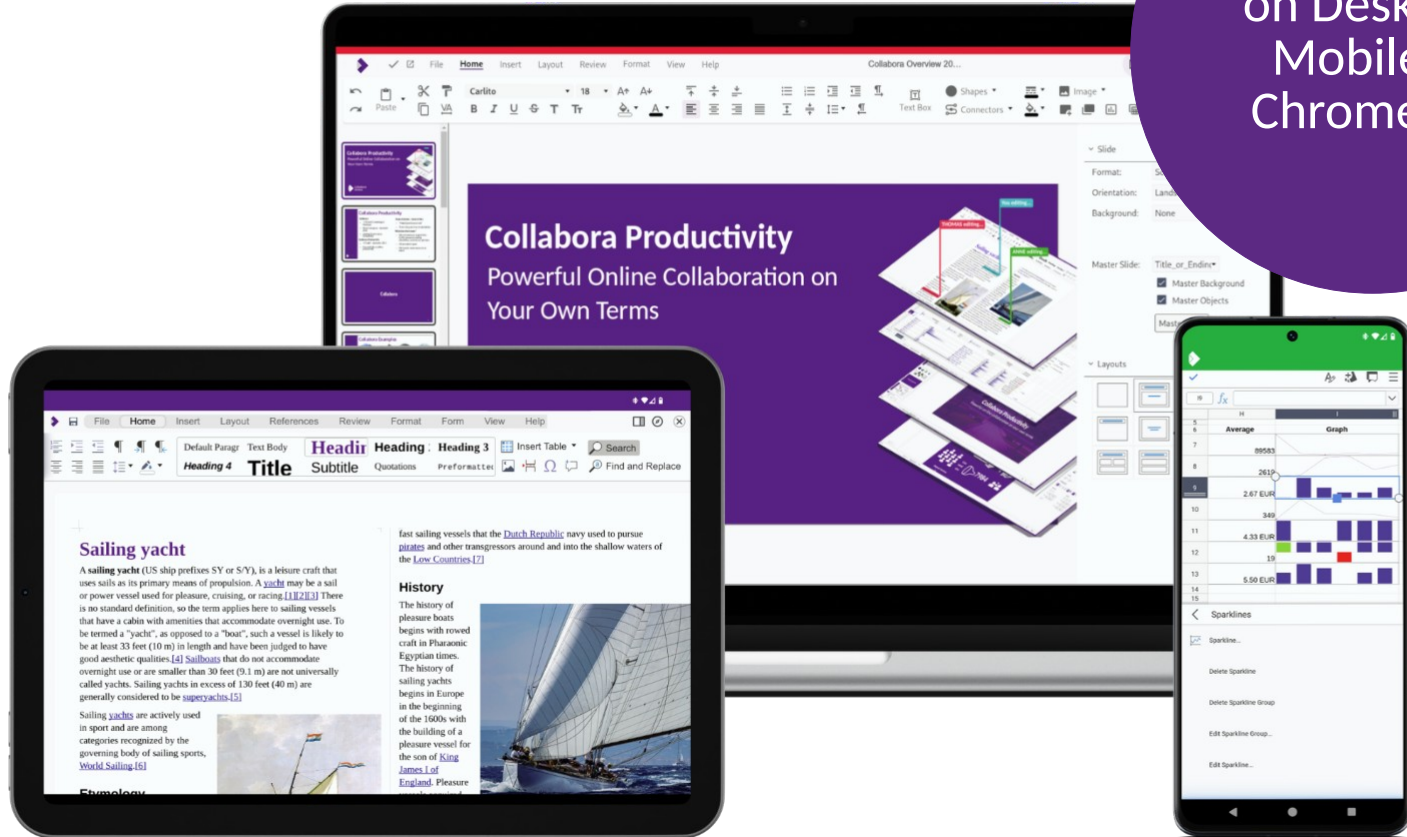

# Collabora Online for You

Collabora Productivity Case Study

Collabora Productivity Ltd provides Duden Korrektor functionality for BFA Staatendokumentation



Collabora Productivity SURF ownCloud Case Study

How ownCloud and Collabora Online Increased Productivity In the Dutch University and Research Landscape

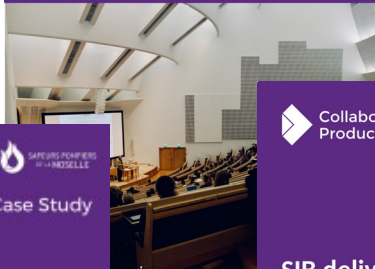

Collabora Productivity Case Study

Open Source helps students learn from home during lockdown



Collabora Productivity arawa SAFIERS POMPIERS DE LA MOSELLE Case Study

Extinguishing Barriers of a Diverse Workforce



Collabora Productivity Nextcloud Case Study

SIB delivering Nextcloud to 2500 teachers and 33000 pupils in Brittany, France

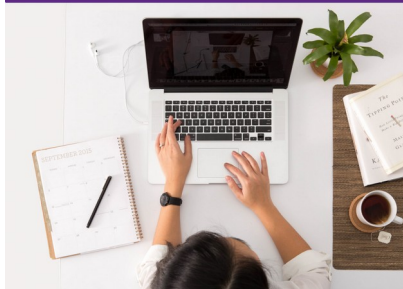

SMBs



Enterprises



Education



Hosting



OEM





# openDesk

Der Souveräne Arbeitsplatz

Including IT-Grundschutz work with Dataport

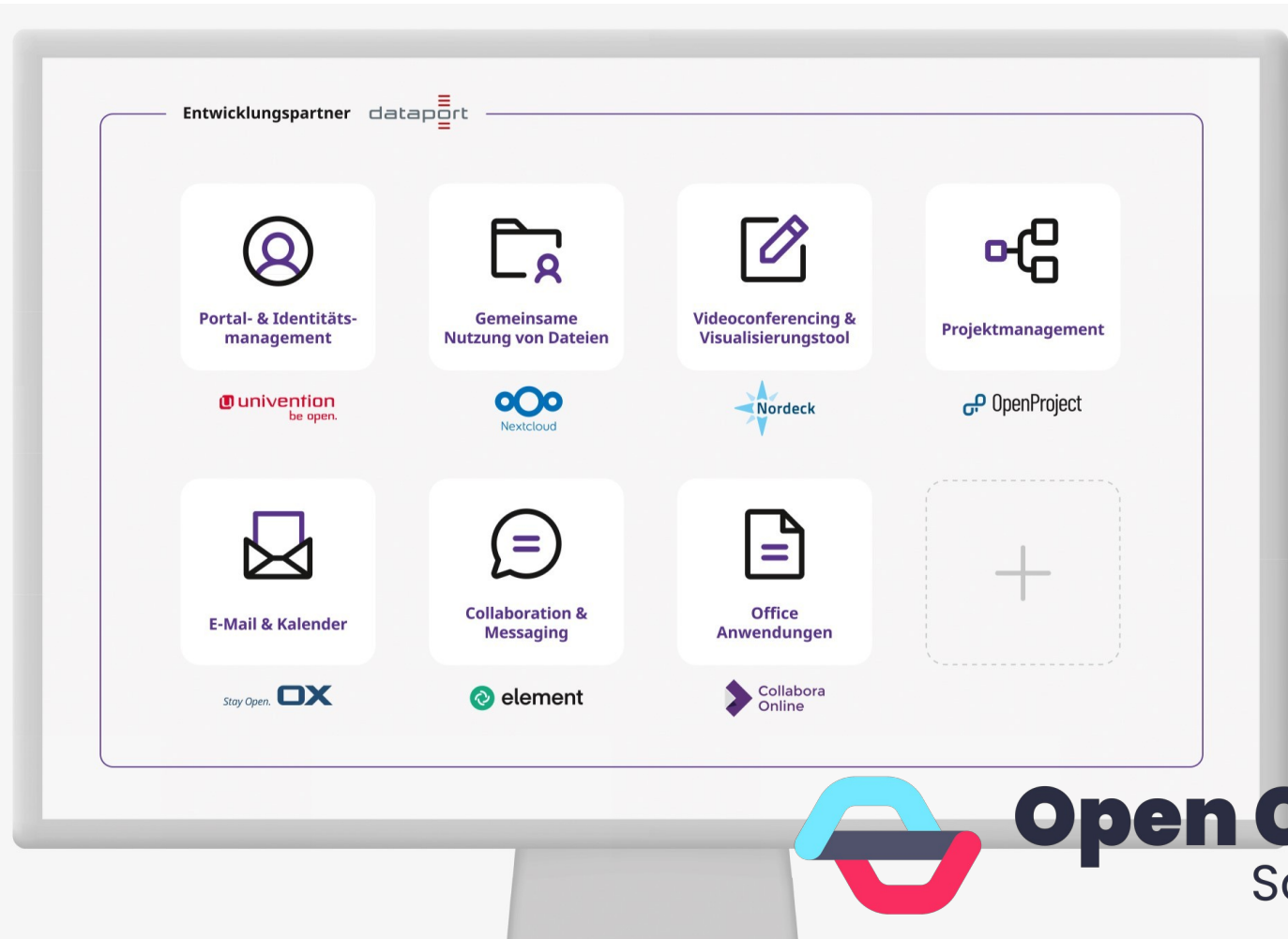

# Collabora Online

## Distinctives

# Friendly Open Source Project



## Real Open Source

- 100% Open Source code
- Built with LibreOffice technology
- Built with Free Software technology stacks: primarily C++
- Runs best on Linux

## Open Development

- Anyone can contribute & participate
- Follow commits and tickets
- Public community calls - forum has details

## Focus

- A non-renewable resource
- Office Productivity & Documents
- Excited about migrating your documents
- Grateful to our partners for solving other problems

# Friendly Open Source Project



## Responsive Support

- Standing behind our customers
- ISO 9001, and ISO 27001 certified

## Sensible licensing

- As many servers & connections & containers & VMs as you need

## “Office for the free world”

- Friendly Developers
  - 50% EU, 75% NATO, global org + LibreOffice technology community
- Friendly Investors
  - 50/50 ~Canada/UK
- Engineers that can travel to you
- Clean hands

# Document Security

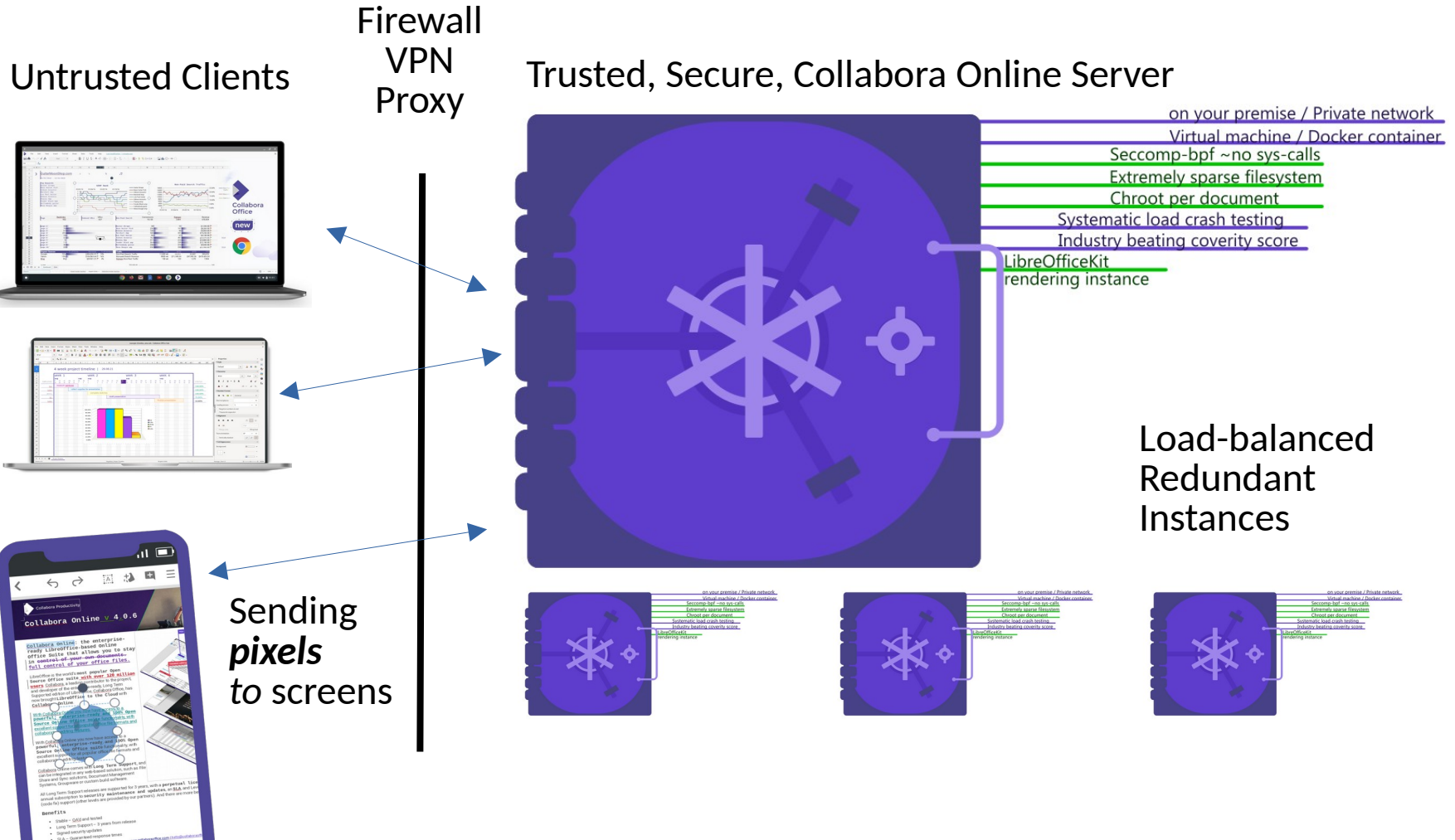



# Highly Available, Simple to Scale, Multi-Tenant

Just grab our helm-chart

- Incremental / available upgrade-ability
- No extra services
- Management (eg. Kubernetes)

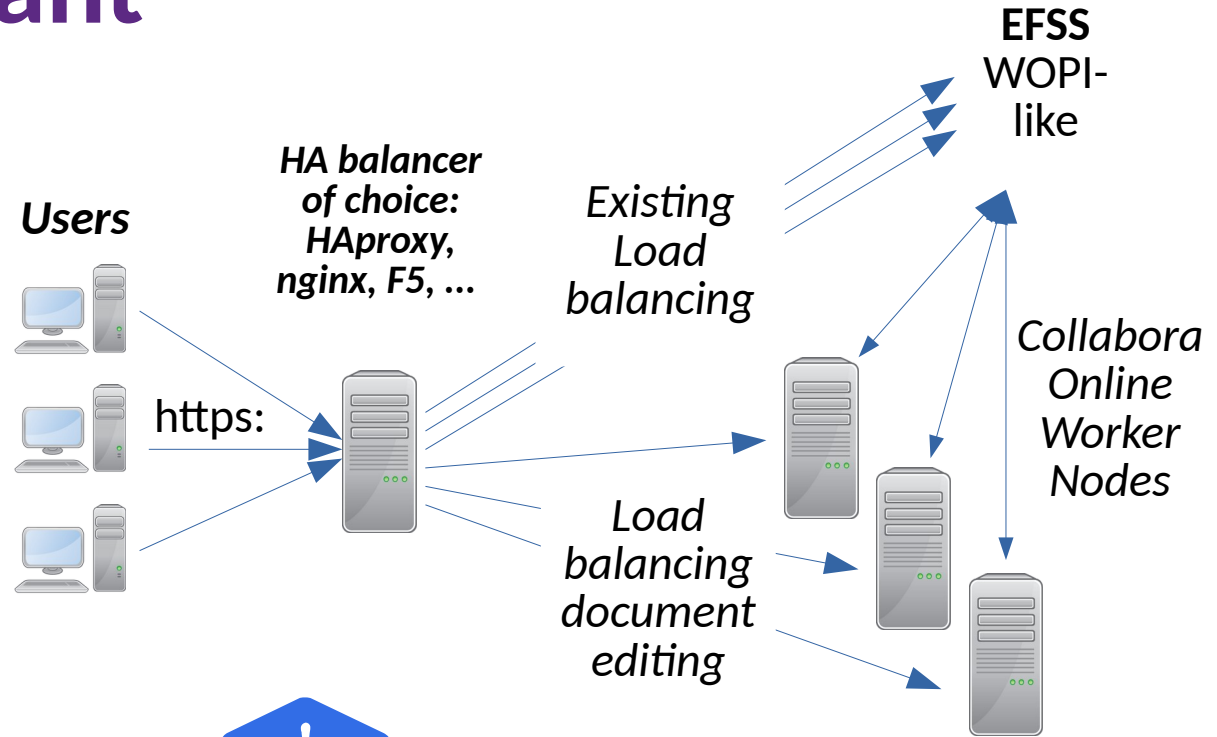

# Latest Features in 24.04

Lots of work over the past year – let us free  
your documents!

# 3D Transitions



# Auto Align and Ruler Bar

The screenshot shows the LibreOffice Impress interface. The main slide is titled "Performance Tuning" and contains a bulleted list: "Reduced time to load graphic heavy Impress slide decks, and comment heavy Calc spreadsheets." Below the text are two 3D bar charts. The first chart, titled "Impress 5 Full-Screen Presentation-Generation", compares "Before" (grey bar, ~3.8 seconds) and "After" (purple bar, ~2.2 seconds) performance. The second chart, titled "Calc XLSX Comments Load", compares "Before" (grey bar, ~6.5 seconds) and "After" (purple bar, ~4.5 seconds) performance. A black crosshair icon is positioned between the two charts. The interface includes a menu bar (File, Home, Insert, Layout, Review, Format, Draw, View, Help), a toolbar with "Position and Size" options (Flip Vertically, Flip Horizontally, Line Colour, Fill Colour, To Curve, Group, Exit Group, Text Box, Connectors), a slide navigation pane on the left, and a status bar at the bottom showing "Slide 51 of 68 | English (UK) | Edit" and "85%".

# Interactive Objects

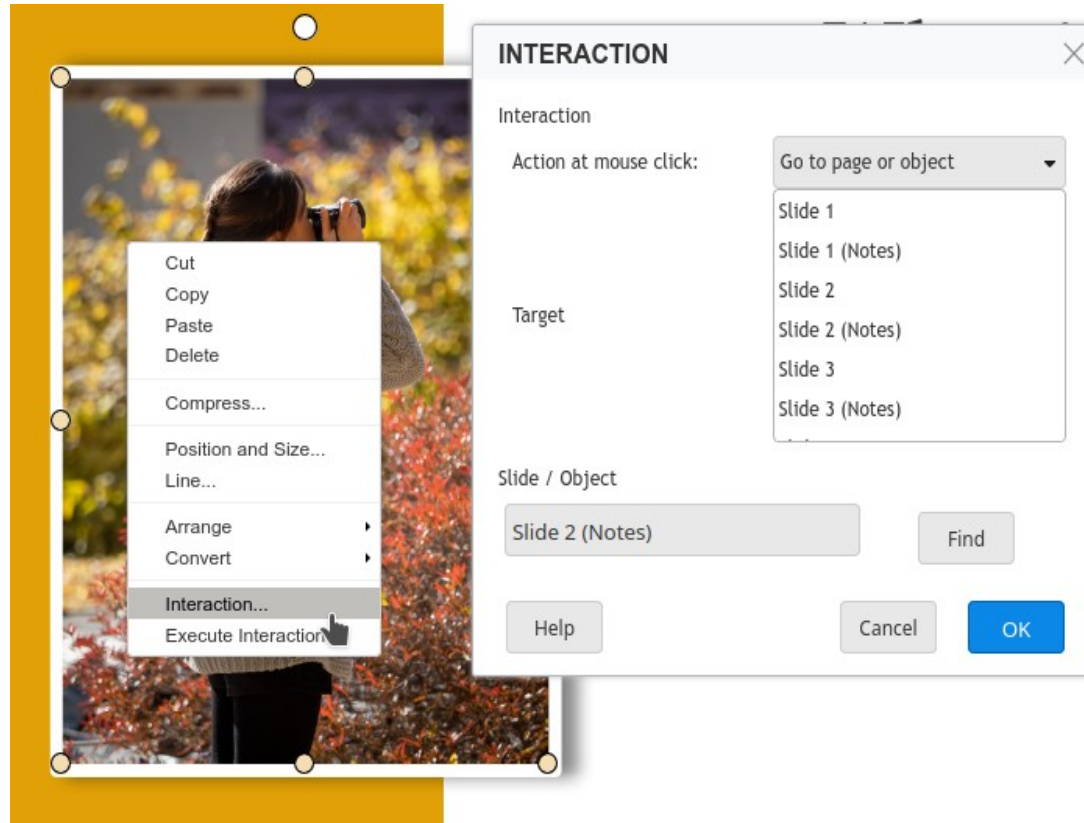

ISO?

speed. I  
ow sensi

d under  
enses/by/2.0/



# Present in Window

- New option to present slides in a new window (as opposed to a full-screen presentation)
  - Useful for video conferencing and large screens

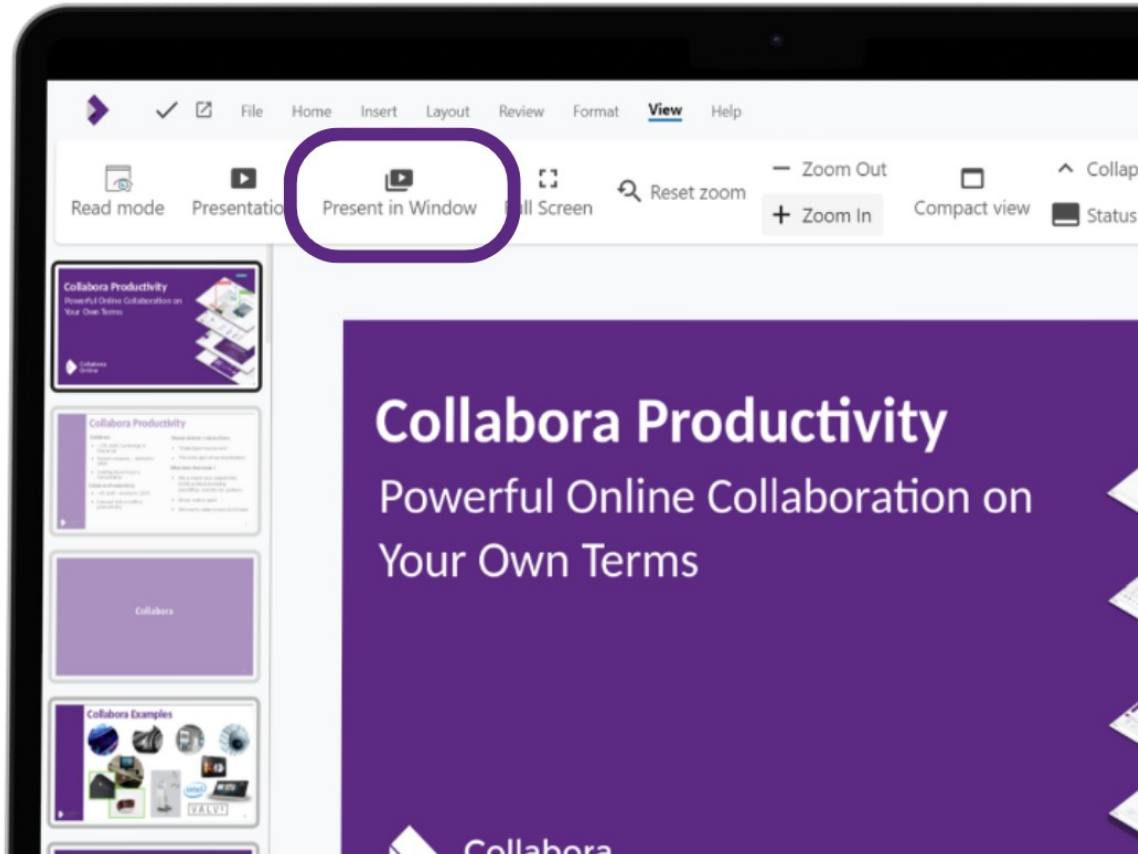

# Usability

- Hide/Show slides in Impress

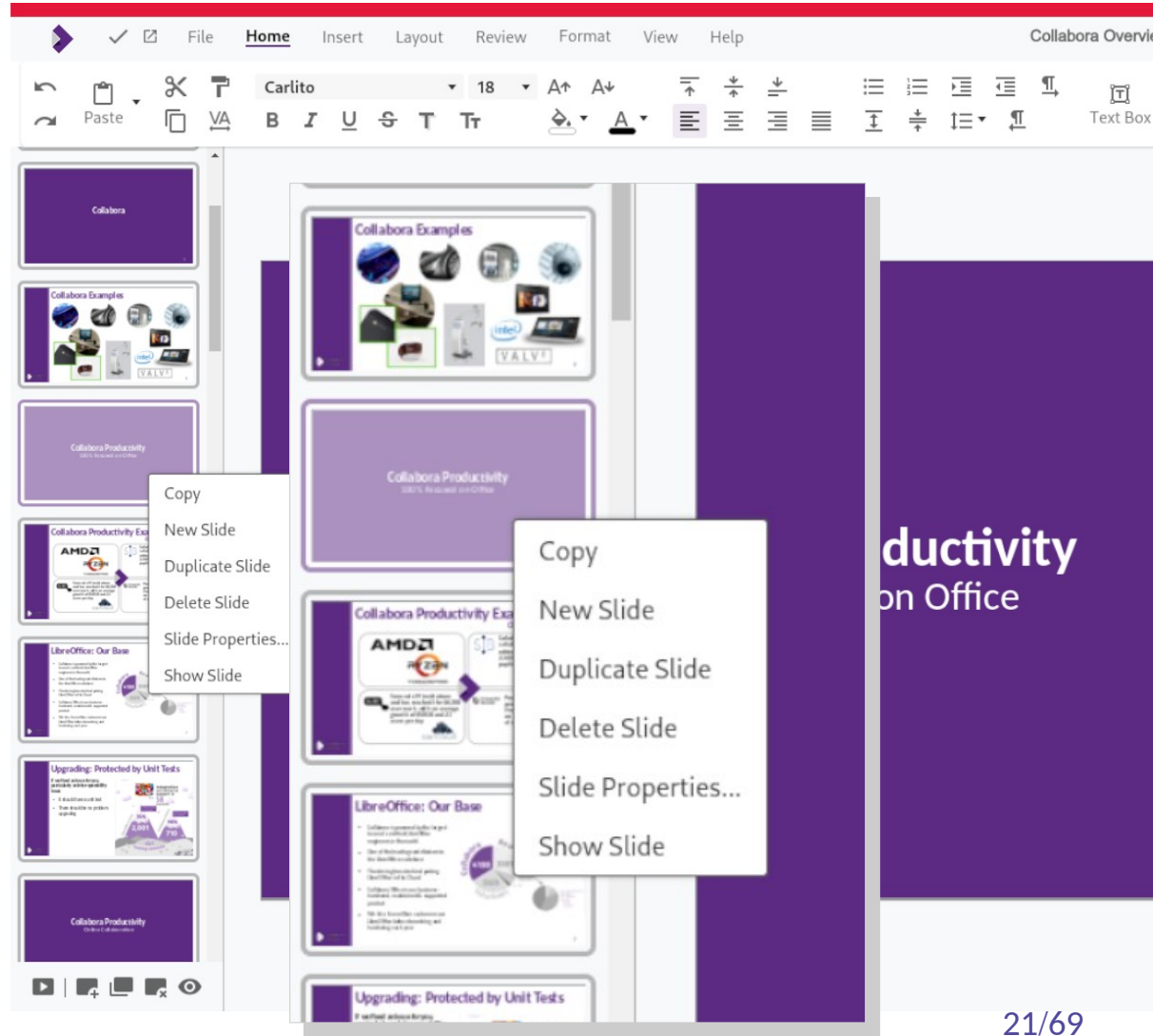

# Present in Window



## Fender Stratocaster

- Double-cutaway solid body design;
- Three single-coil pickups;
- Tremolo bridge system;
- 5-way pickup selector switch;
- Bolt-on neck construction;
- Versatile tone suitable for various music genres.

## Fender Stratocaster

- Double-cutaway solid body design;
- Three single-coil pickups;
- Tremolo bridge system;
- 5-way pickup selector switch;
- Bolt-on neck construction;
- Versatile tone suitable for various music genres.

# Automatic Documents

- Create final PDFs
- or
- Create prefilled ODP/DOCX documents to continue working on

The screenshot shows the LibreOffice Writer interface with a form titled "INWARD REPORT (SHIPS AND BOATS OTHER THAN SMALL CRAFT)". The form is for the New Zealand Customs Service. A purple box highlights the "Form" toolbar, which includes icons for Rich Text, Checkbox, Dropdown, Picture, Date, and Properties. The form contains several fields for data entry, including ship name, date of arrival, and a calendar for the date of arrival. The calendar shows the month of September 2024, with the 24th highlighted. The form also includes a section for "PART A: ARRIVAL DETAILS" and a section for "LIST SUBSEQUENT PORTS OF CALL WITHIN NEW ZEALAND".

PART A: ARRIVAL DETAILS							
Name of ship	HMB Endeavour			Port of arrival	Poverty Bay		
Date of arrival	10/01/1769	Time of arrival	Click here to enter text				
Name of person in charge	James Cook			Port arrived from	Plymouth		
IMO number	Click here to enter text			Name and address of ship's agent in New Zealand			
Gross register tonnes	Click here to enter text			Click here to enter text			
Period of stay in New Zealand	Choose a date						
IF CARRYING CARGO, BRIEF DESCRIPTION							
LIST SUBSEQUENT PORTS OF CALL WITHIN NEW ZEALAND							
Next New Zealand ports	1	2	3	4	5	6	7
1. Auckland	8	9	10	11	12	13	14
2. Wellington	15	16	17	18	19	20	21
3. Click here to enter text	22	23	24	25	26	27	28
4. Click here to enter text							
5. Click here to enter text							

# Automatic Documents

Properties of "docStructureChartExampleOriginal"

General Description Custom Properties Font Statistics

Title: \_\_\_\_\_

Subject: \_\_\_\_\_

Keywords: \_\_\_\_\_

Contributor: \_\_\_\_\_

Coverage: \_\_\_\_\_

Identifier: \_\_\_\_\_

Publisher: \_\_\_\_\_

Relation: \_\_\_\_\_

Rights: \_\_\_\_\_

Source: \_\_\_\_\_

Type: \_\_\_\_\_

Comments: \_\_\_\_\_

Help

```
1 {
2   "Transforms": {
3     "DocumentProperties": {
4       "Title": "Title TxT",
5       "Subject": "Subject TxT",
6       "Keywords": [ ],
7       "Contributor": ["Contributor1 TxT", "Contributor2 TxT"],
8       "Coverage": "Coverage TxT",
9       "Identifier": "Identifier TxT",
10      "Publisher": ["Publisher TxT", "Publisher2 TxT"],
11      "Relation": ["Relation TxT", "Relation2 TxT"],
12      "Rights": "Rights TxT",
13      "Source": "Source TxT",
14      "Type": "Type TxT",
15      "Description": "Description TxT"
16    }
17  }
18 }
```

Properties of "temp2"

General Description Custom Properties Font Statistics

Title: Title TxT

Subject: Subject TxT

Keywords: \_\_\_\_\_

Contributor: Contributor1 TxT, Contributor2 TxT

Coverage: Coverage TxT

Identifier: Identifier TxT

Publisher: Publisher TxT, Publisher2 TxT

Relation: Relation TxT, Relation2 TxT

Rights: Rights TxT

Source: Source TxT

Type: Type TxT

Comments: Description TxT

Help Cancel OK

- With simple JSON
  - Add/remove file properties
  - Create 'Custom Properties'



# Automatic Documents

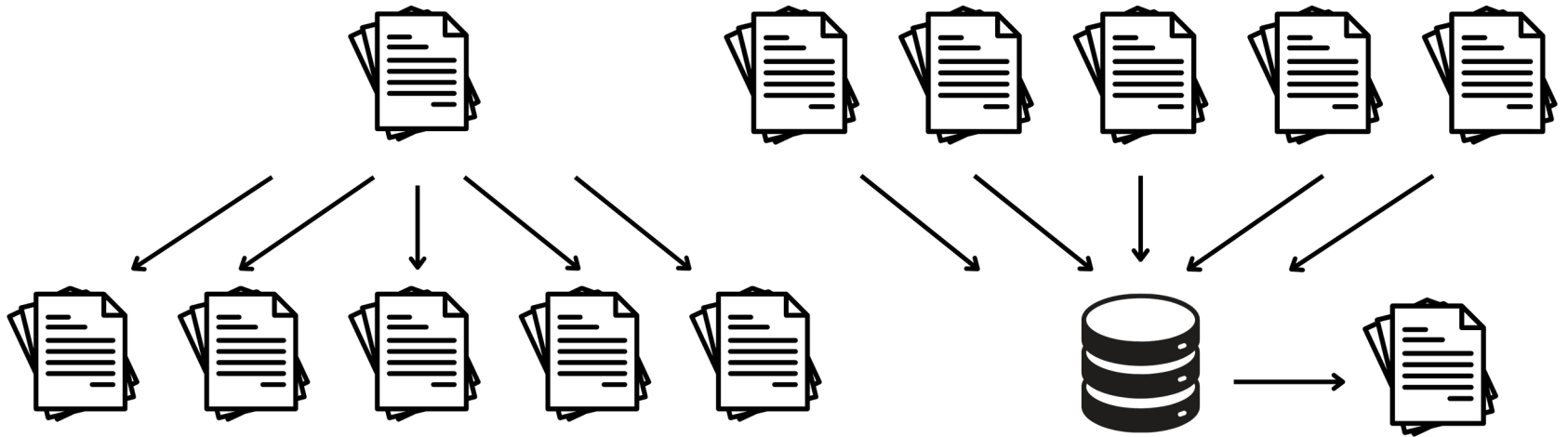

# Automatic Documents

## Example Integration: Nextcloud

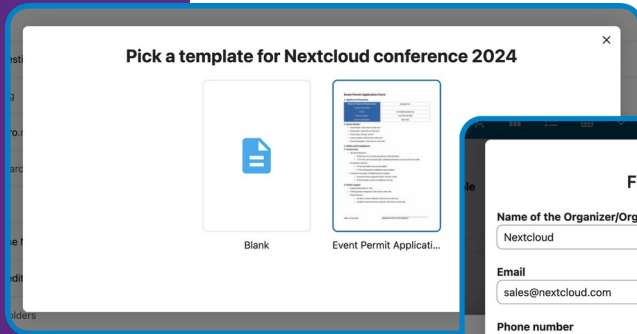

Fill template fields

Name of the Organizer/Organization  
Nextcloud

Email  
sales@nextcloud.com

Phone number  
Phone number

Event Coordinator  
Event Coordinator

Event name  
Nextcloud Conference 2024

Event date  
Event date

Event location  
Event location

Event description  
Event description

Minimum of 2 security guards per 100 attendees

On-site communication plan established between security staff

First aid station set up and staffed

Review   Format   Form   **View**   Help

Nextcloud conference 2024...

Event Permit Application Form

1. Applicant Information

Name of Organizer/Organization:	Nextcloud
Contact Information	
Email:	sales@nextcloud.com
Phone Number:	+49 1234 567890
Event Coordinator:	Jane Doe

2. Event Details:

- Event Name: Nextcloud Conference 2024

1. Applicant Information

Name of Organizer/Organization:	Nextcloud
Contact Information	
Email:	sales@nextcloud.com
Phone Number:	+49 1234 567890
Event Coordinator:	Jane Doe

2. Event Details:

- Event Name: Nextcloud Conference 2024
- Event Date: [Click here to enter text](#)

Page 1 of 2 | 184 words, 1,169 characters | Insert   Standard selection   German (Germany)

# Server Mis-configurations?

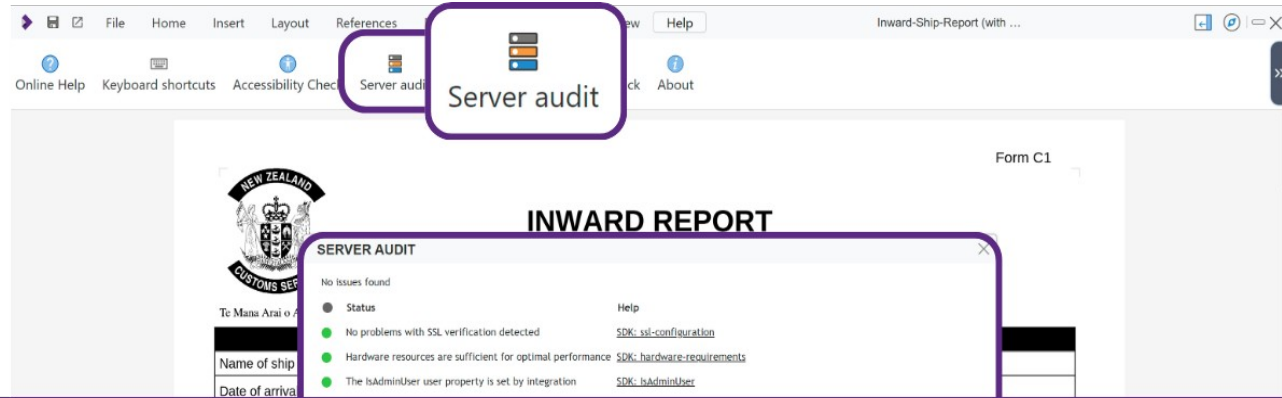

### SERVER AUDIT

No issues found

Status	Help
● No problems with SSL verification detected	<a href="#">SDK: ssl-configuration</a>
● Hardware resources are sufficient for optimal performance	<a href="#">SDK: hardware-requirements</a>
● The IsAdminUser user property is set by integration	<a href="#">SDK: IsAdminUser</a>
● PostMessage API is initialized	<a href="#">SDK: post-message-initialization</a>

OK

# Follow the Editor

The image shows a laptop screen displaying the LibreOffice Writer application. The document is titled "Following the editor" and contains the following text:

## The Colleges of Cambridge

The [University of Cambridge](#)<sup>1</sup> is composed of 31 [colleges](#) in addition to the academic departments and administration of the central university. Until the mid-19th century, both Cambridge and Oxford comprised a group of colleges with a small central university administration, rather than universities in the common sense. Cambridge's colleges are communities of students, academics and staff - an environment in which generations and academic disciplines are able to mix, with both students and fellows experiencing "the breadth and excellence of a top University at an intimate level".

### Accommodation

Cambridge colleges provide most of the accommodation for [undergraduates](#) and [postgraduates](#) at the university. At the undergraduate level they have responsibility for admitting students to the university, providing pastoral support, and organising elements of their tuition, though



On the right side of the screen, there is a vertical sidebar with a purple border. At the top, there are five circular icons representing different users. Below these, a list of names is shown, each preceded by a circular icon: You, Sophie, Dean, Ryder, Ash, Sam, Luna, and Grace. At the bottom of the sidebar, there is a checkbox labeled "Always follow the editor".

# Search for help

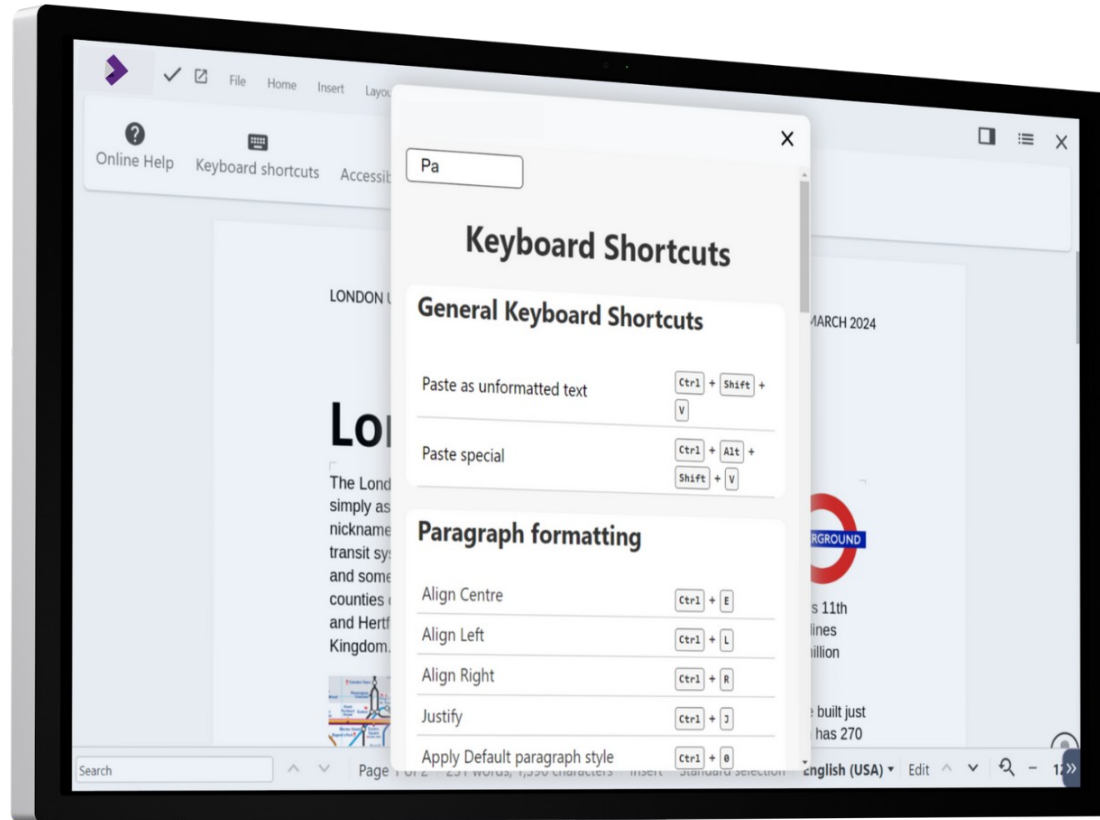

# Clearer Tracked Changes

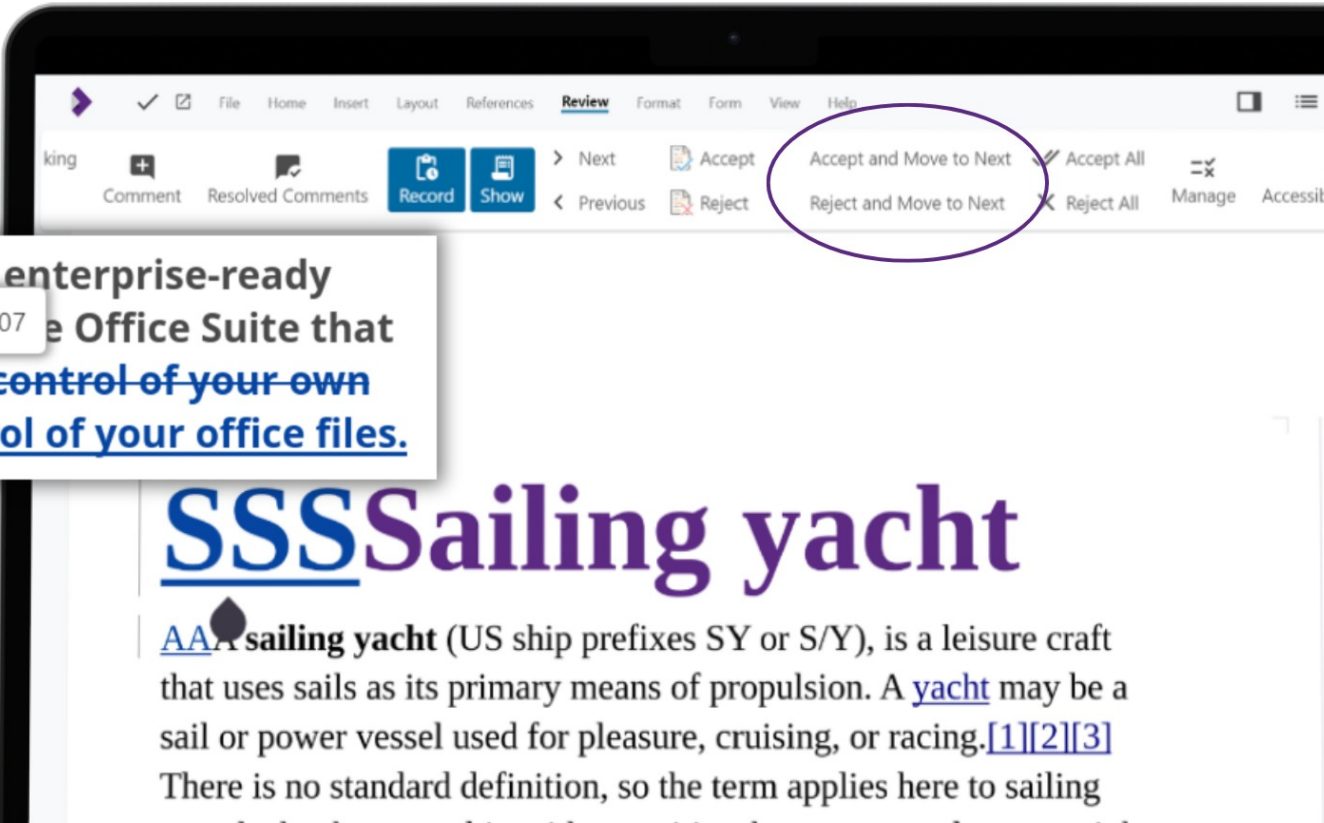

**Collabora Online: the enterprise-ready**  
Deleted: Alan - 04/27/2017 17:11:07  
**Office Suite that**  
**allows you to stay in ~~control of your own~~**  
**~~documents. full control of your office files.~~**

## SSS Sailing yacht

AA sailing yacht (US ship prefixes SY or S/Y), is a leisure craft that uses sails as its primary means of propulsion. A yacht may be a sail or power vessel used for pleasure, cruising, or racing.<sup>[1][2][3]</sup>  
There is no standard definition, so the term applies here to sailing

# Contextual Tooltips

- Start to type a formula and a list of available formulas appear

The image shows a spreadsheet interface with a data table and a formula bar. A tooltip for the VLOOKUP function is displayed over the formula bar, and another tooltip for the SUM function is displayed over the formula bar in a lower section of the spreadsheet.

£18.00	124	£1,784.00	113	14	50
£19.00	112	£2,128.00	75	11	50
£24.00	182	£4,368.00	132	15	150
£29.00	106	£3,074.00	142	1	150
£75.00	173	£12,975.00	127	9	100
£14.00	28	£392.00	21	8	50

VLOOKUP( Search criterion, Array, Index, Sorted range lookup ) : The value to be found in

=VLOOKUP(|

[SUM], SUMIF, SUMIFS and 5 more : Returns the sum of all arguments.

=sum|

Freeze pane



# PDF Improvements

- Generating accessible PDFs with PDF/UA export
- Exporting to PDF v.1.7 by default
- Tagged PDFs produced by default
  - Include hidden accessibility markups to improve the reading experience with screen readers and other assistive technologies
- Hybrid PDFs now storing original ODF documents
  - For sharing documents with others as a pdf, while retaining the functionality of being able to modify the original file

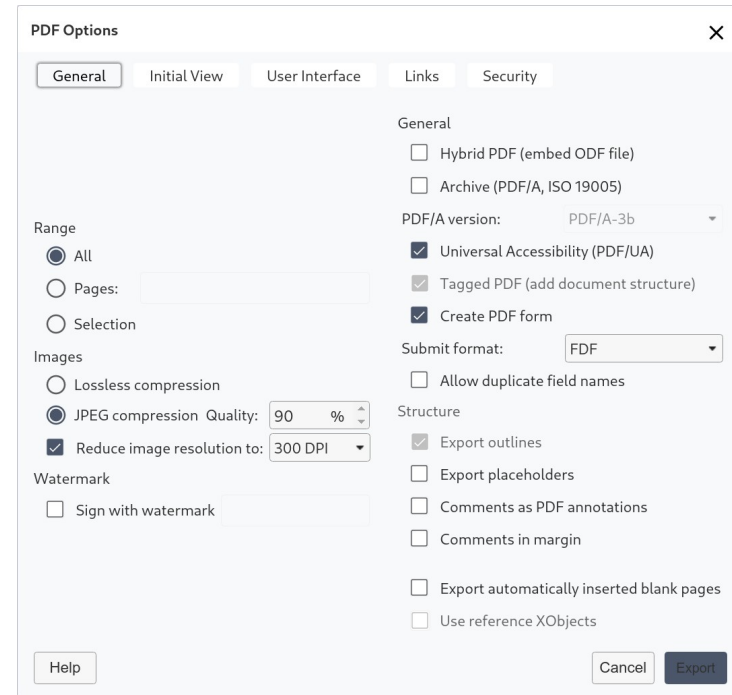

# Continued Accessibility Wins

- Screen reading & keyboard usability wins
- Processing lots of Audit results
  - Actively fixing and polishing large numbers of improvements
- Target full WCAG 2.0 AA conformance



# Cell Protection and Section Editing

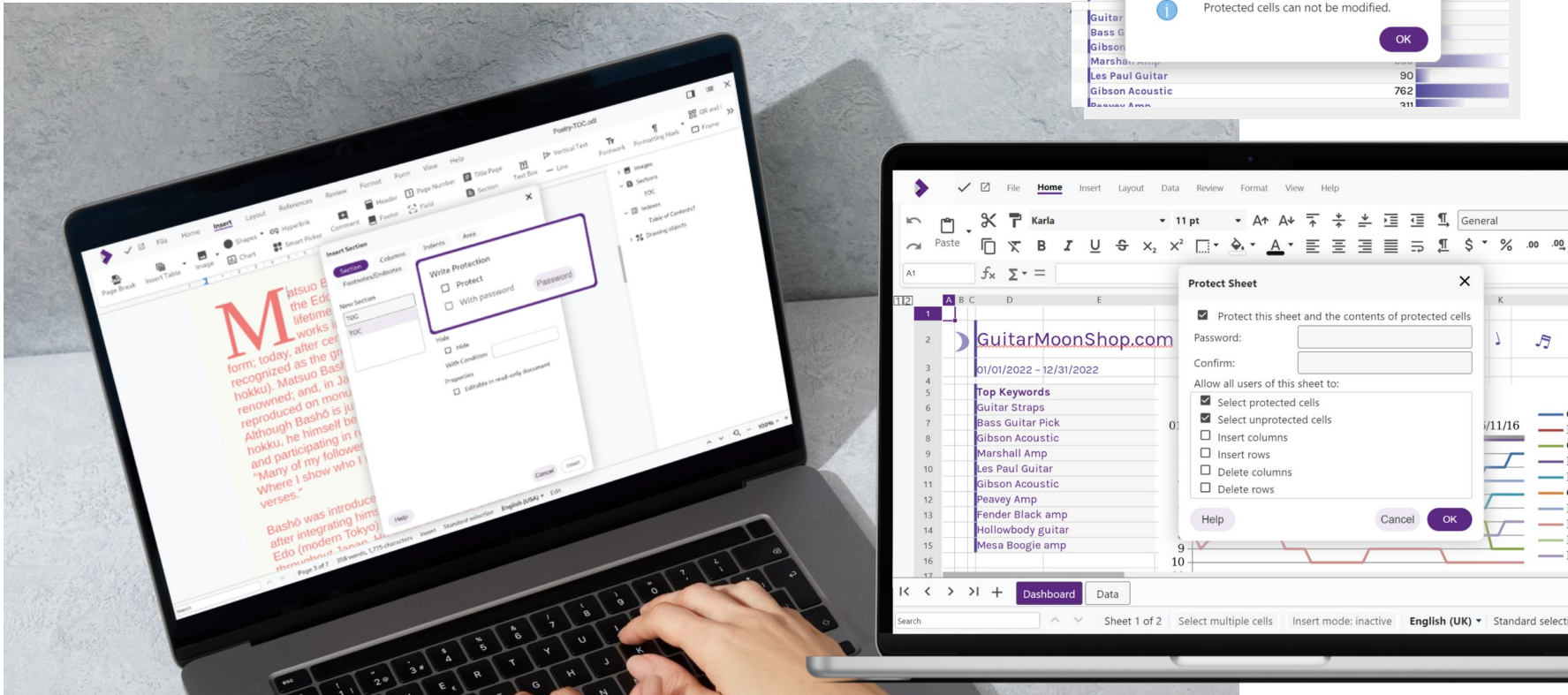

# New Filter Options

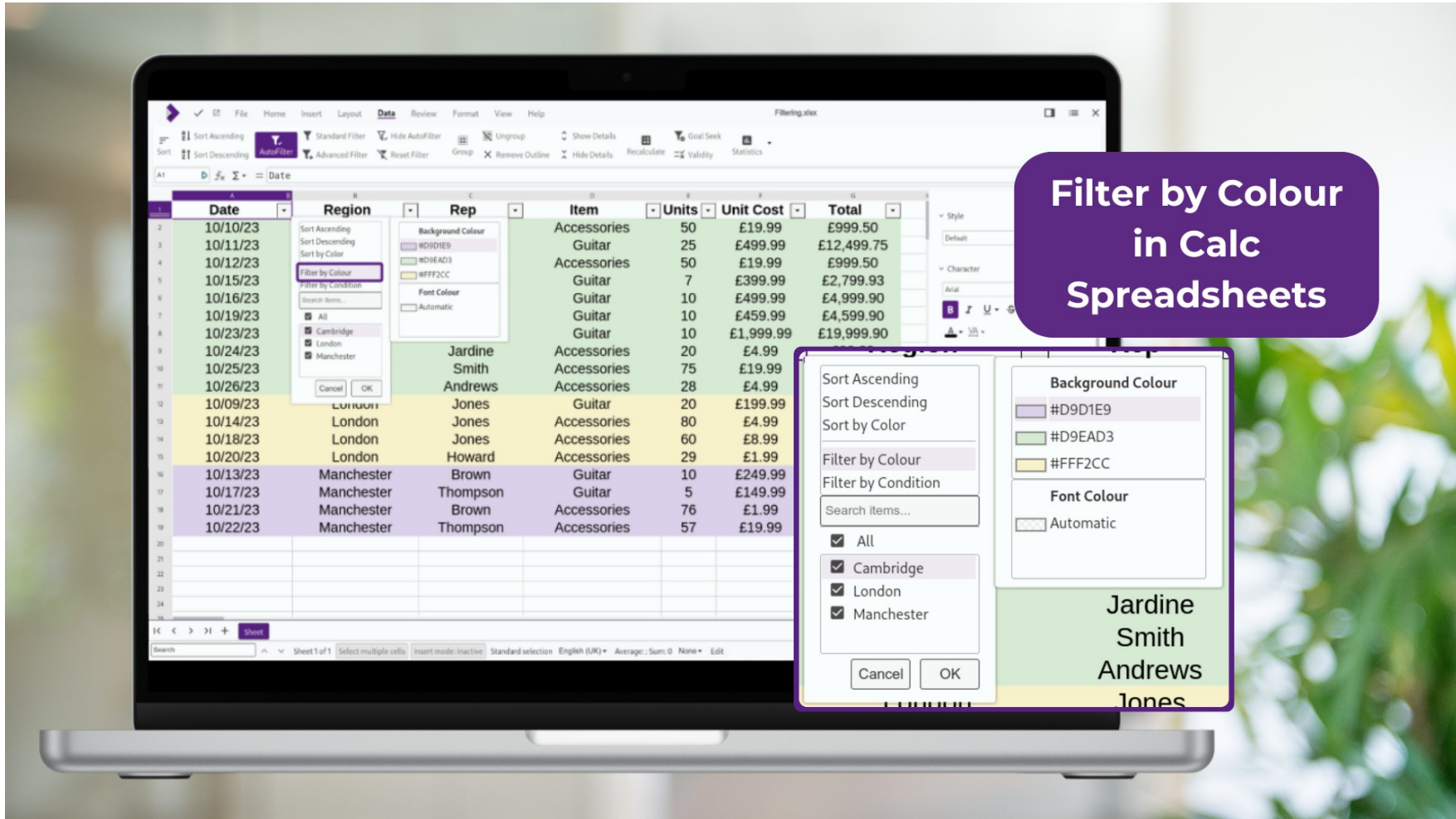

# Improved Read-Only Mode

- Previously, read-only access was not interactive
- Now we offer more granular control for documents and spreadsheets
  - Allow users to select document text
  - Improved accessibility
- Plus you can now follow hyperlinks in read-only documents



# Rootless Containers

- User running the container has no special privileges
- Now achieved with Linux Namespaces



# Background (Auto) Save

- Saving can now be carried out in the background
- Fewer interruptions to editing
- 700ms before the animation, 7ms to fork...

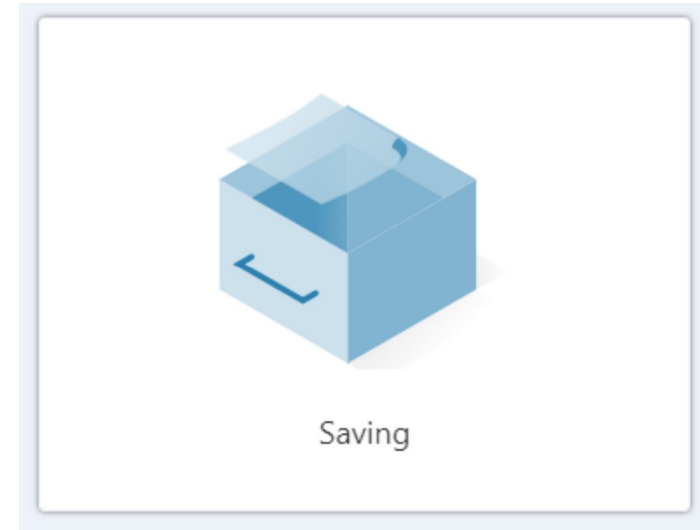

*Fewer interruptions with 24.04*



# Interoperability

# Simplifying Copy and Paste

- Toolbar buttons work as expected
- Easier for the end user
- No download required

If you want to share large elements outside of Nextcloud Office it's necessary to first download them. [Download \(Ctrl + C\)](#)

Download completed and ready to be copied to clipboard. [Copy \(Ctrl + C\)](#)

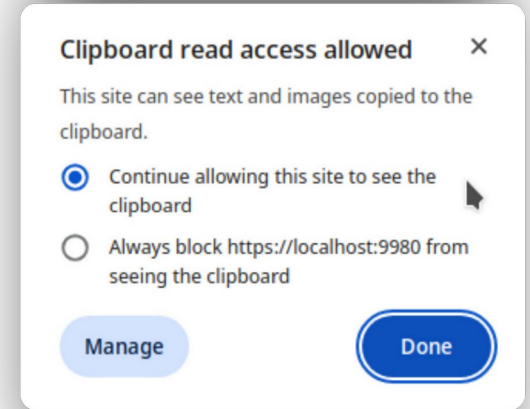

## *New clipboard API pop-up*

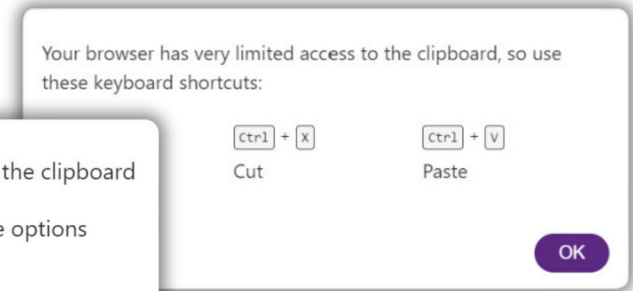
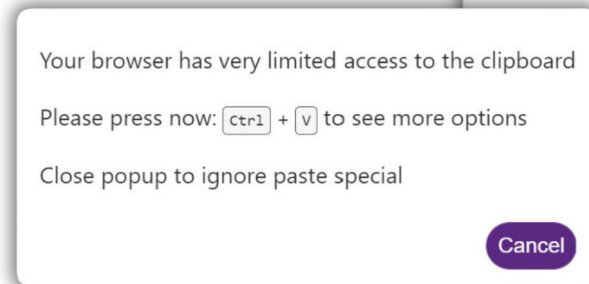

# HTML Copy/paste with Google Sheets

- Reverse-engineered and documented Google Sheets extensions
  - Preserves formulae vs values and styling
  - Ensuring that data copied from Calc includes markers such as `<google-sheets-html-origin/>` to fully work with Google Sheets
- Help Collabora Office Desktop ↔ Collabora Online copy/paste as well as from Google Sheets

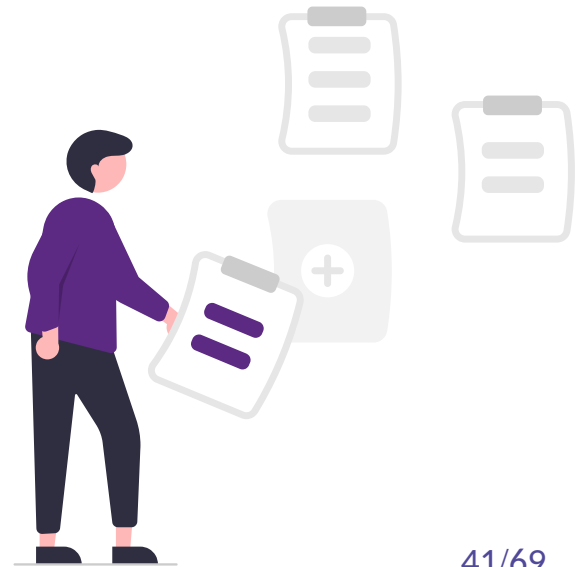

# Improved Graphics Support

- Previously SVGs would default to the fallback PNG
  - OOXML should now render the SVG image correctly
- Three interoperability issues related to Windows EMF and EMF+ files have also been resolved
- Smoother experience when working with SVGs, EMF and EMF+ files



# STYLEREF

- Create dynamic headers or footers that automatically update based on changes in the document.

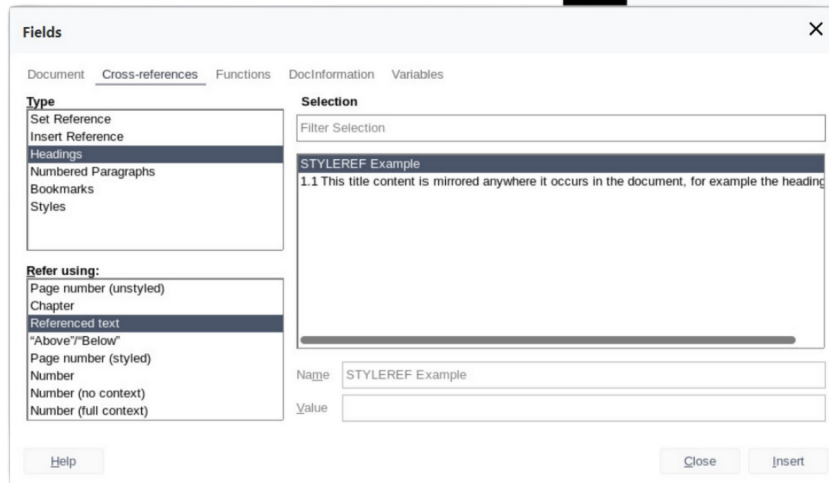
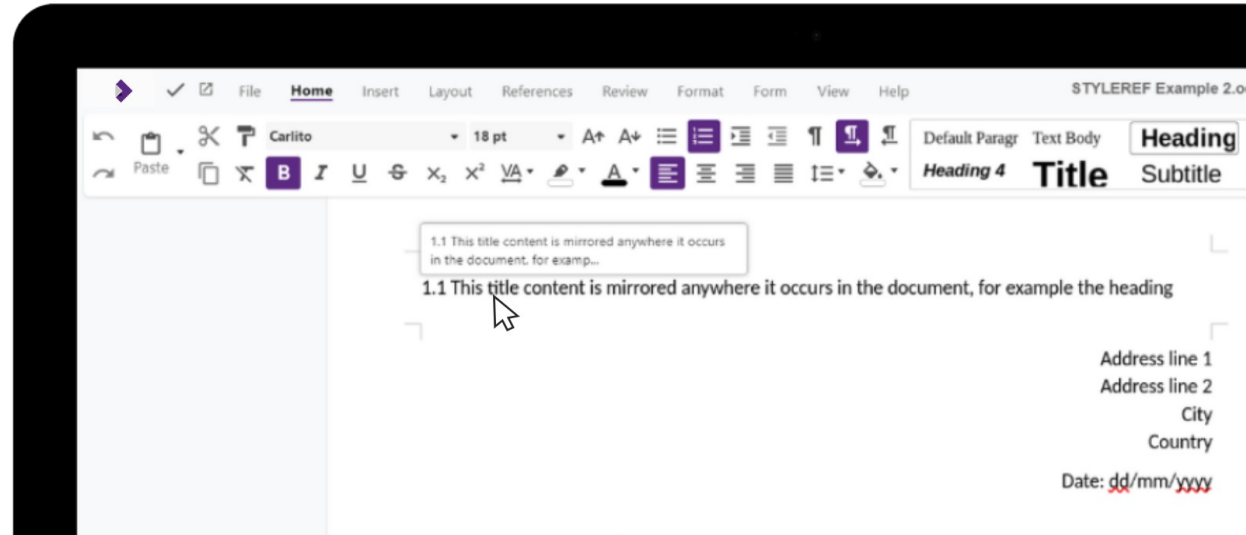

## Draft Legal Document

### STYLEREF Example

Below is a title, formatted with the 'Heading 1' style.

Writer can now insert a STYLEREF cross-reference field, so that the content is updated anywhere it is used, for examples headers and footers.

**1.1 This title content is mirrored anywhere it occurs in the document, for example the heading**

By mirroring the content of titles, you can make sure you always know what section of a document

# Performance

# 2x Faster Document Loading

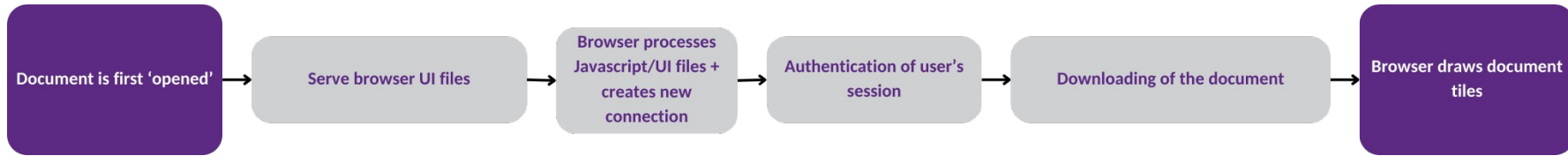

Previously in series

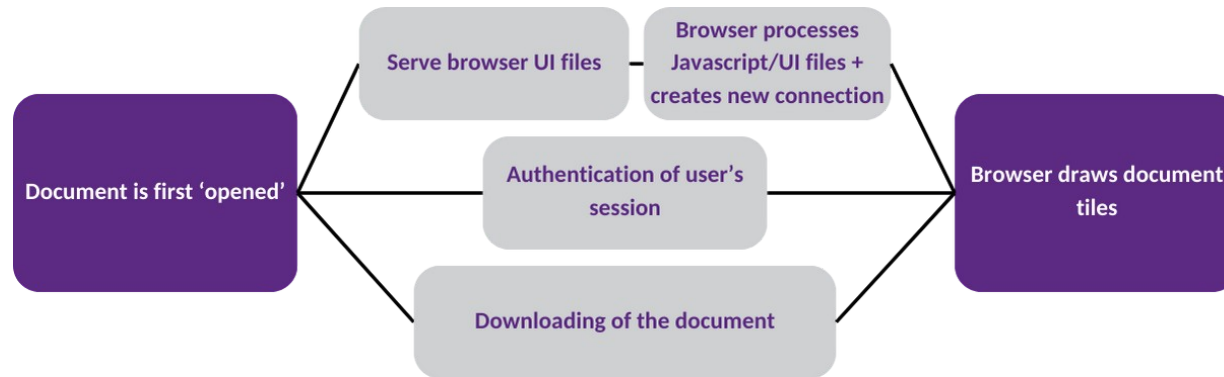

Up to 2x faster in parallel



# Up to ~18x Faster Tile Compression

- This speed-boost stacks two improvements
  - 4.5x performance from run length encoding
  - 4x performance improvement from improved threading
- Combined for ~18x speed boost for tiles



# Improved Threading in Calc

- We tested time for loading, recalculation, and saving
- 650,000 test spreadsheets
- Time reduced from 3 days, to 36 hours
  - ~2x speedup

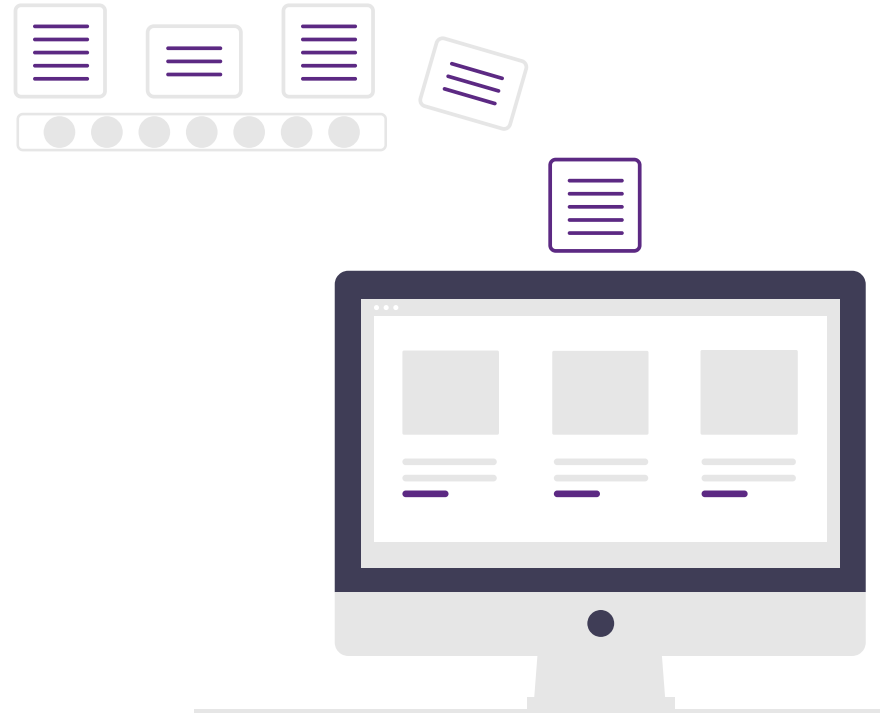

# Long Running Demo Profiles: A Week

What does it mean?

- 17% of a week of profiling:
- Detecting: “is it a Hybrid PDF”?
- Unbelievably wasteful
- Scan last 4k block ‘AdditionalStreams’ +17%

Width is proportional time

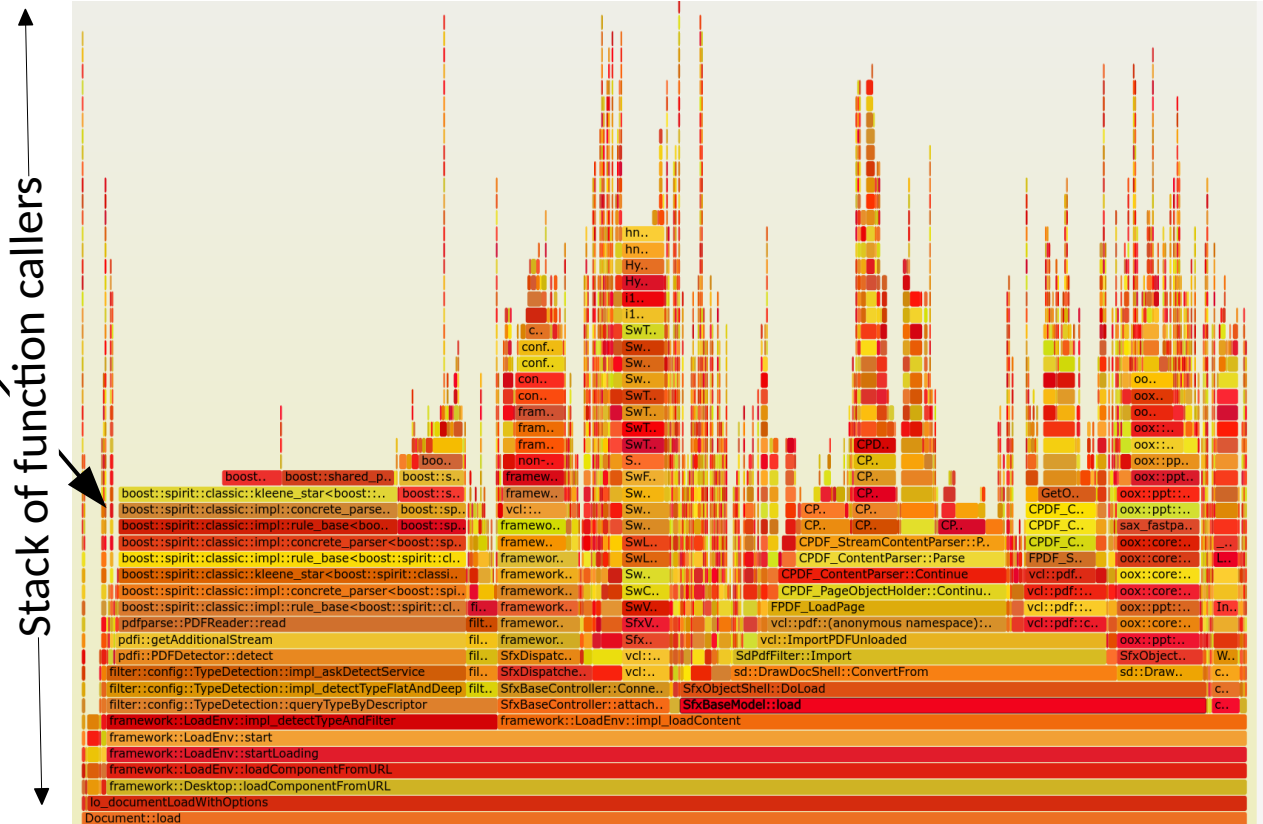

# Rendering Tiles 40% of Your Profile ?

Lots of unnecessary re-rendering

- Pruning the simple cases out

Silliness in various places

- Now much improved

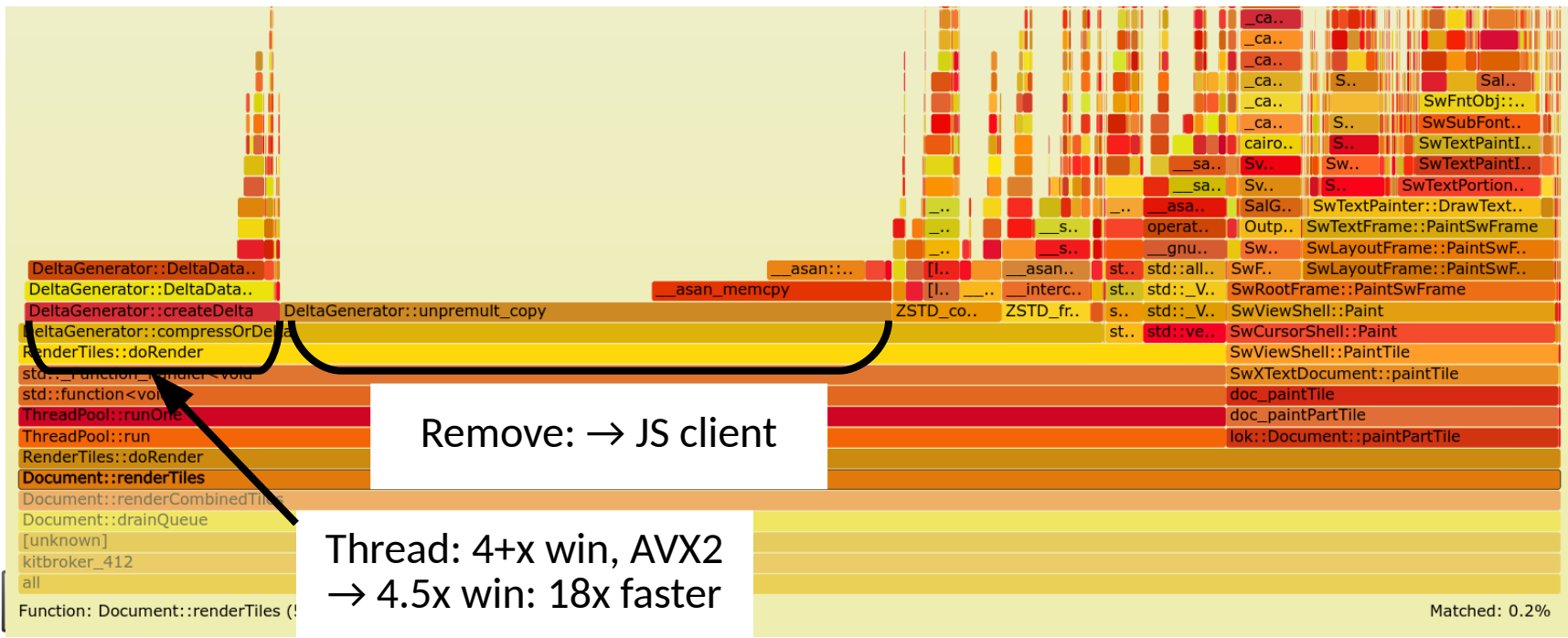

# The Magic of AVX2 – Branch Free RLE

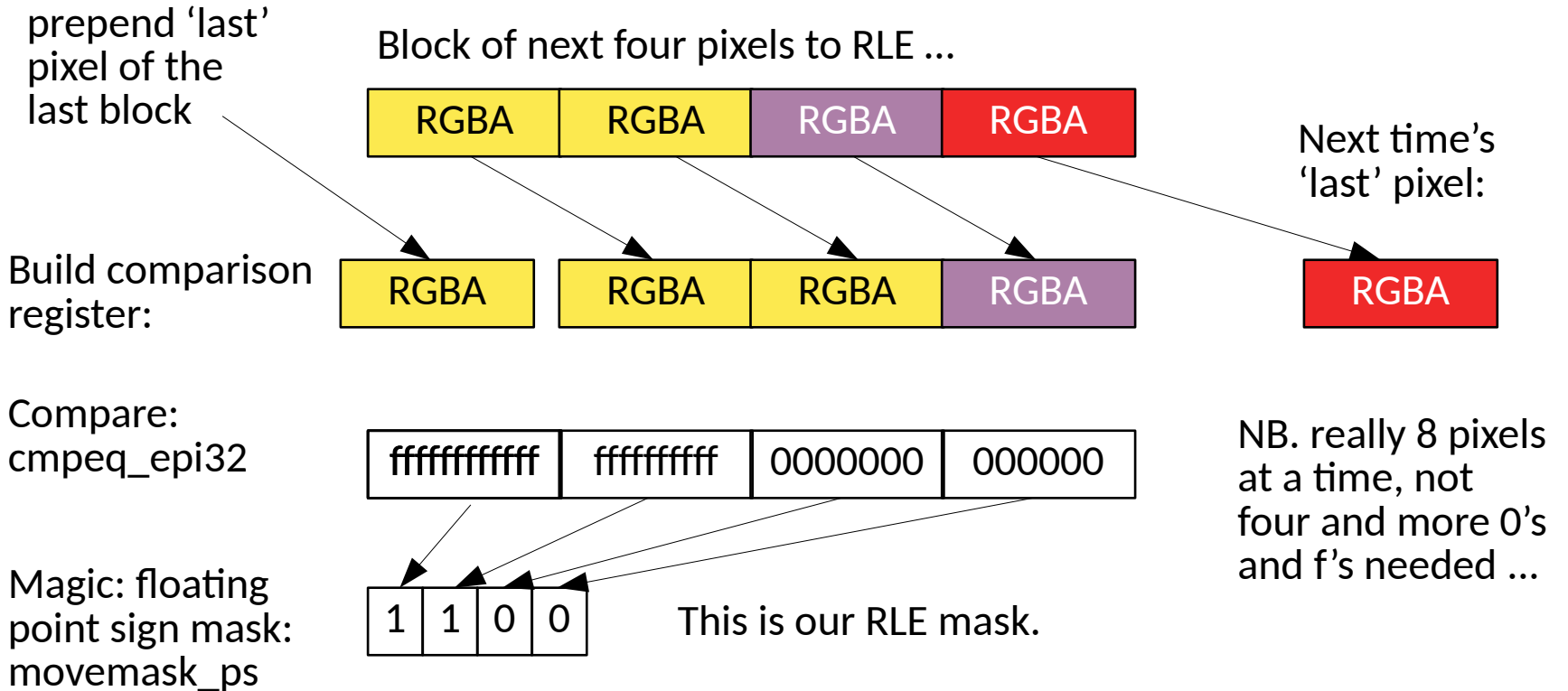

NB. really 8 pixels at a time, not four and more 0's and f's needed ...

How many pixels to copy? `popcount(RLE mask)`  
Which ones? RLE Mask → LUT + AVX2 gather  
`permutevar8x32_epi32 ...` is your friend

# Performance – Faster & Simpler

## A faster, slicker experience

- Memory trimming on idle: cleans caches & frees up memory
- Swap out compressed image data as well as uncompressed
- Faster load of large spreadsheets
- Significantly reduced re-rendering (even more pending)
- Continual style re-thumbnailling redux – caching of generated JSON
- Improved tile pre-loading (with more caching work queued)
- Clamp over-sizing of threads
- Accelerated transparent text rendering
- Avoid background whole document renders
- Compress RLE'd tiles on the wire
- Scan /proc/<pid>/smaps\_rollup

# Performance Tuning

- Much faster for many operations – for example – multiple users to join a shared Writer document and scroll through a long, heavy Writer document.

Joining Writer Shared Document

Writer document with 5 pages. 20 users joining simultaneously, until all clients rendered. perf stat -e cycles

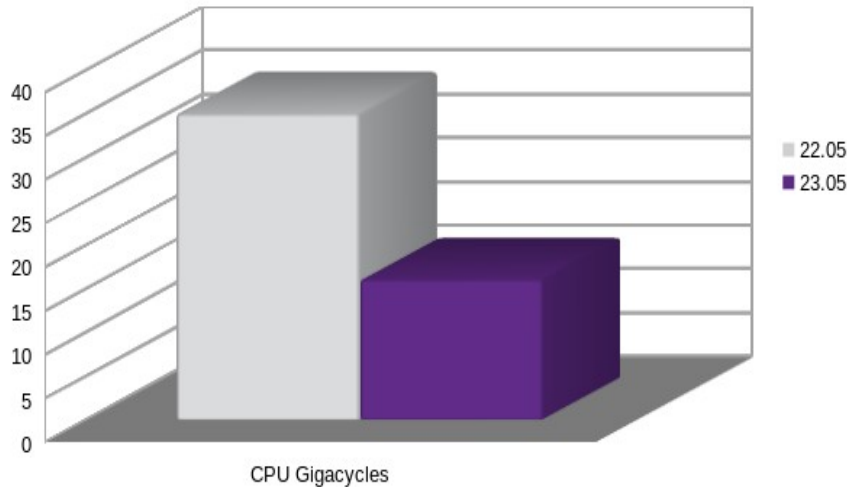

Writer Scrolling

Writer document with 157 pages, 164 shapes, 32 comments, 13 images, 115 tables. Wheel scrolled from start to end. perf stat -e cycles

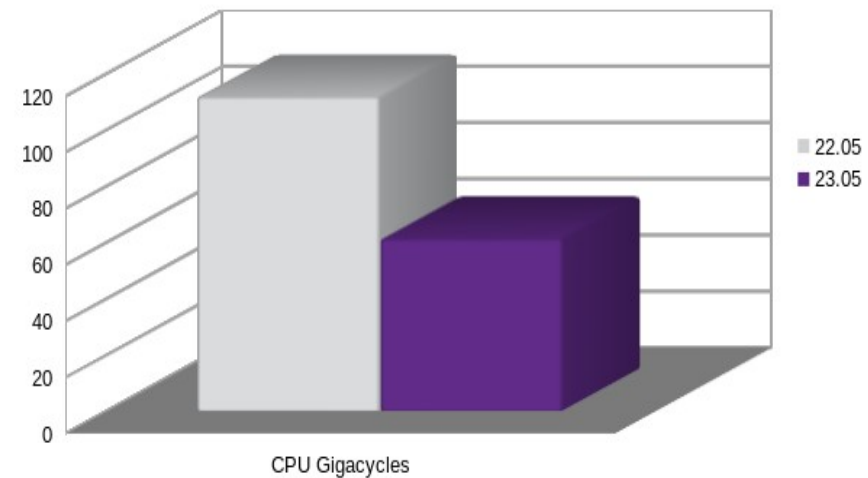



# Performance Tuning

- Reduced time to load graphic heavy Impress slide decks, and comment heavy Calc spreadsheets.

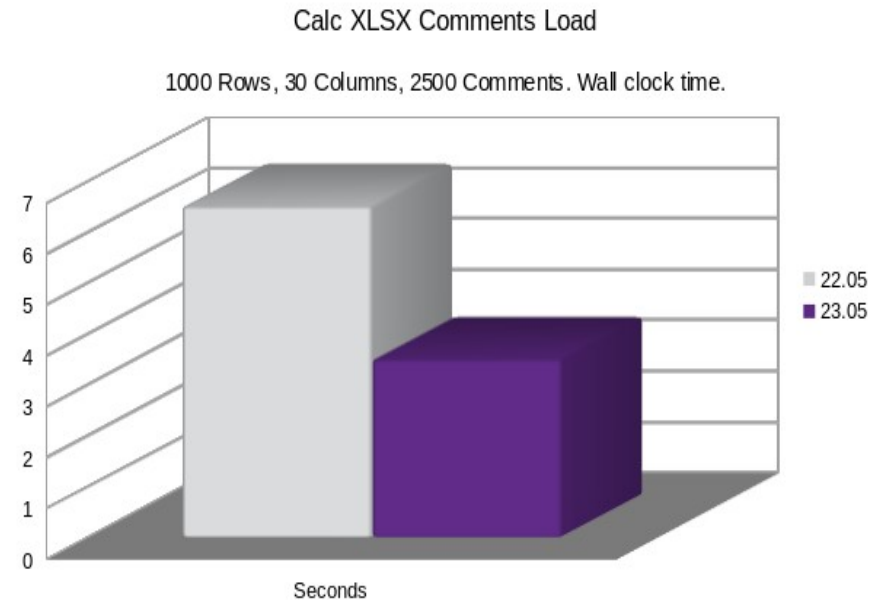
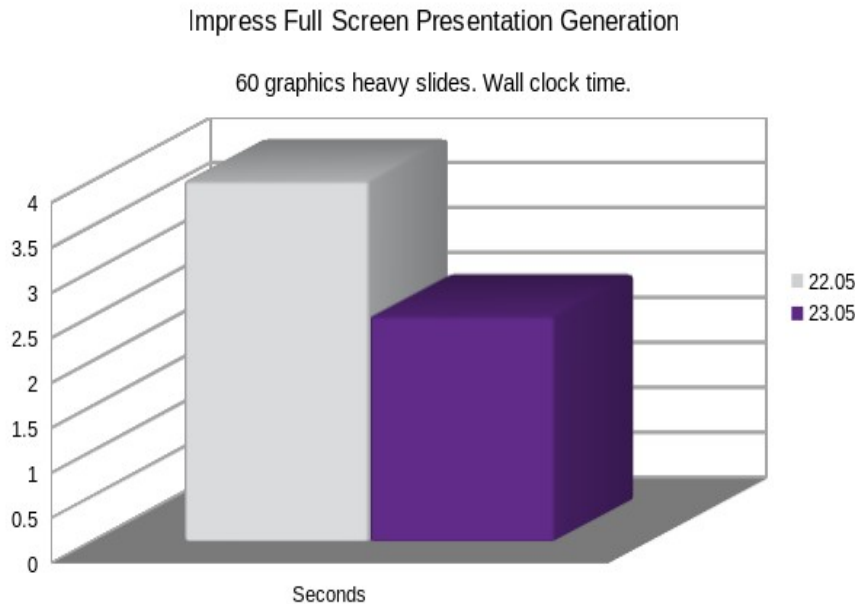

# Other Recent Updates

# Drupal Integration

Manage Shortcuts hub

View profile Edit profile Log out

Home

## Architecture

View Edit Delete Revisions

File View Help IntegrationArch.odg

Web page Application Server

Demo form

Submit

Hidden form

JSON: wopi url and token

Search Page 1 of 1 Read-only

Back to site Manage Shortcuts hub Announcements Edit

Content Structure Appearance Extend Configuration People Reports Help

Media name Type Published status Language Filter

Thumbnail	Media name	Type	Author	Status	Updated	Operations
<input type="checkbox"/>	<a href="#">Sales Projections.ods</a>	Office Document	hub	Published	06/10/2024 - 17:13	<b>Edit</b> View in Collabora Online Edit in Collabora Online Delete
<input type="checkbox"/>	<a href="#">Sample Word Docum</a>					<b>Edit</b>
<input type="checkbox"/>	<a href="#">Sample Open Docum</a>					<b>Edit</b>

**Edit**  
View in Collabora Online  
Edit in Collabora Online  
Delete

Collabora Online

# Accessibility Features



Dark Mode

---

Initial Screen Reading Support

---

Keyboard Navigation

---

Accessibility Checker

---

PDF/UA

---

Find out more: [col.la/accessibility](https://collabora.com/la/accessibility)

# Accessibility

## Dark Mode

- Also added various UI properties per-view: eg. non-printing characters, spell-underlines etc.

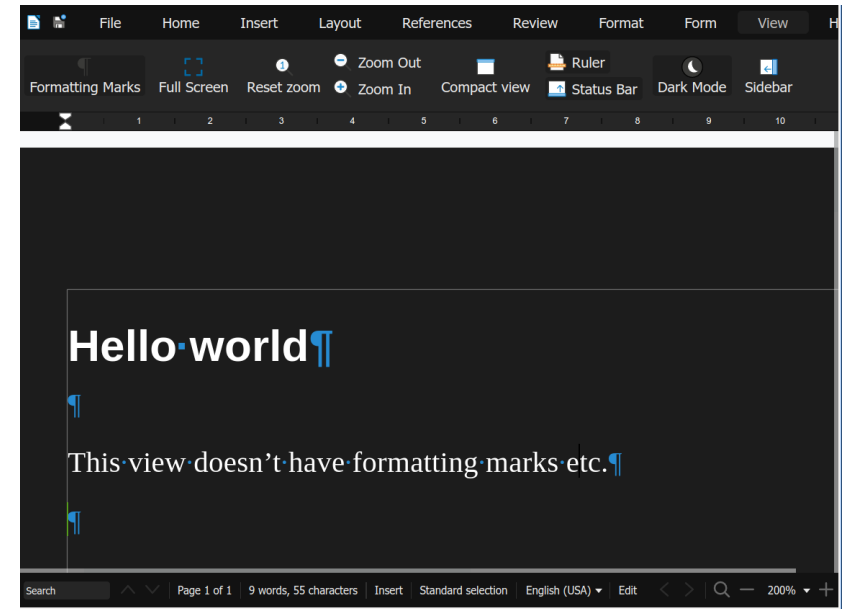
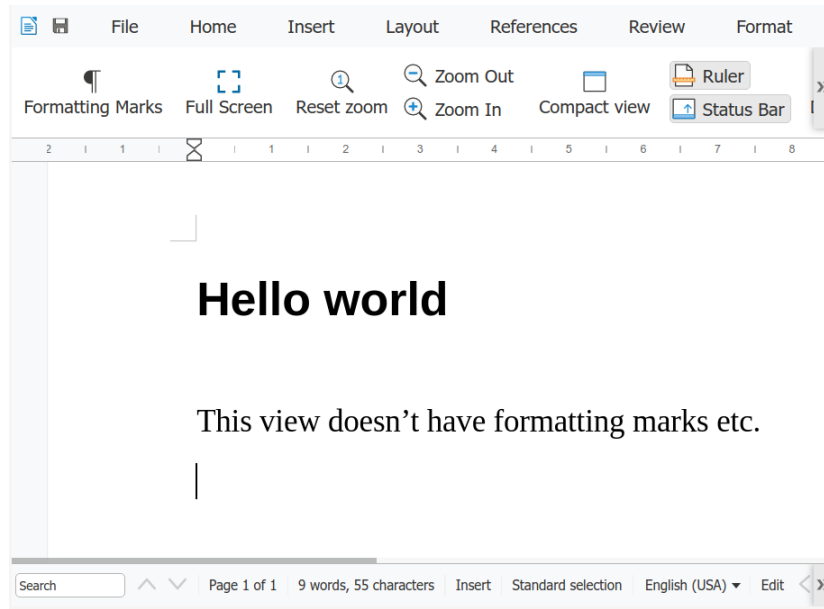

# Accessibility

## Keyboard Accelerators

- Expansion for languages
  - Keyboard shortcuts have been expanded to allow all users to be able to use their own language's keyboard shortcuts when editing a file collaboratively.
  - Holding down the 'Alt' key will also highlight options for learnability.

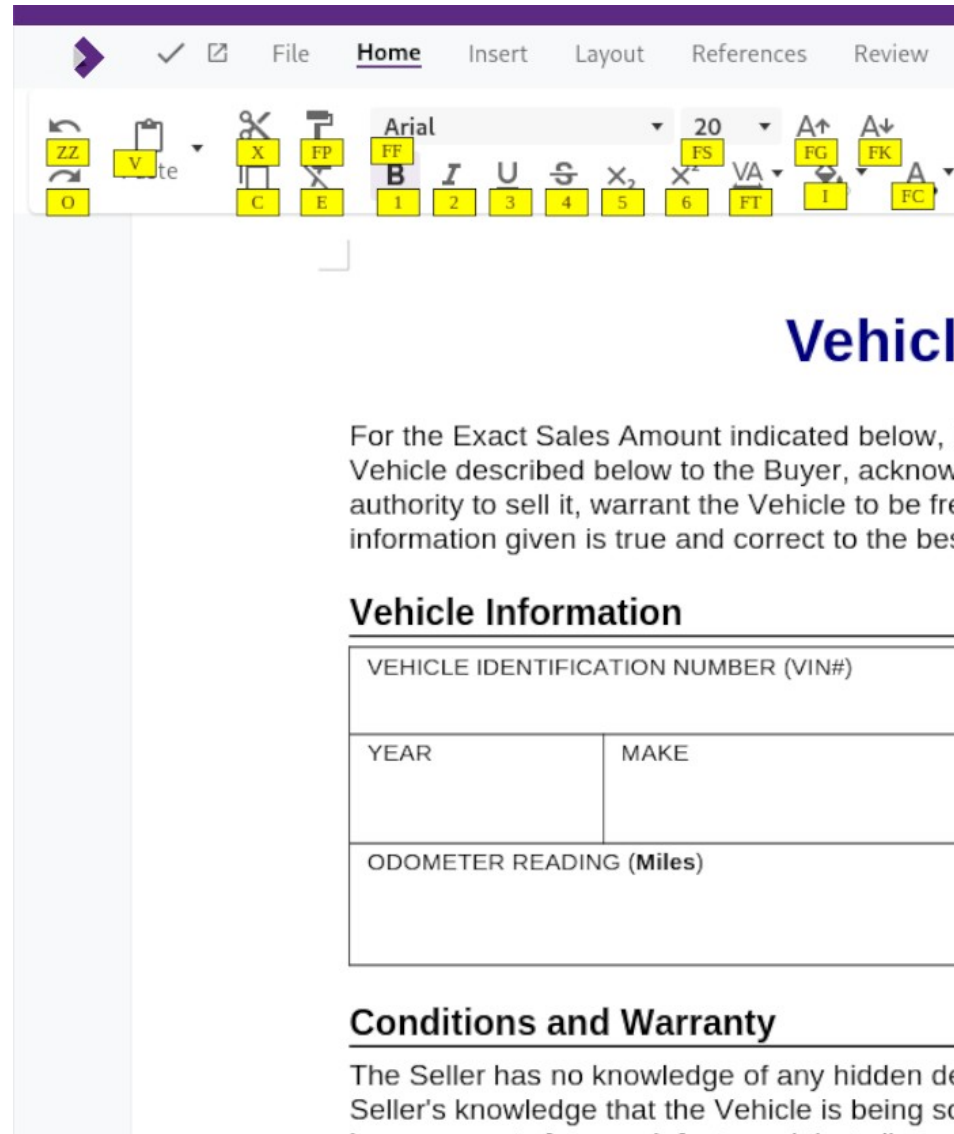

The screenshot shows the LibreOffice Writer application window. The title bar includes a navigation arrow, a checkmark, a document icon, and the menu bar with options: File, Home, Insert, Layout, References, and Review. The ribbon is set to the 'Home' tab, displaying various text formatting options such as Undo, Paste, Cut, Copy, Bold (B), Italic (I), Underline (U), Strikethrough (ABC), Paragraph (P), Bulleted List (B), Numbered List (1), Decrease Indent (L), Increase Indent (R), Font Color (A), Paragraph Color (A), and Text Color (A). The font is set to Arial, size 20. The main text area contains the word "Vehicle" in a large blue font. Below it, there is a paragraph of text: "For the Exact Sales Amount indicated below, Vehicle described below to the Buyer, acknowledge authority to sell it, warrant the Vehicle to be free of information given is true and correct to the best of my knowledge." Below this text is a section titled "Vehicle Information" with a table containing fields for "VEHICLE IDENTIFICATION NUMBER (VIN#)", "YEAR", "MAKE", and "ODOMETER READING (Miles)". At the bottom, there is a section titled "Conditions and Warranty" with the text: "The Seller has no knowledge of any hidden defects. The Seller's knowledge that the Vehicle is being sold is based on the information provided by the Buyer."

# Accessibility

## Page Navigation

- Navigator functionality is viewable in the sidebar, allowing you to jump to each section by simply clicking the headings.

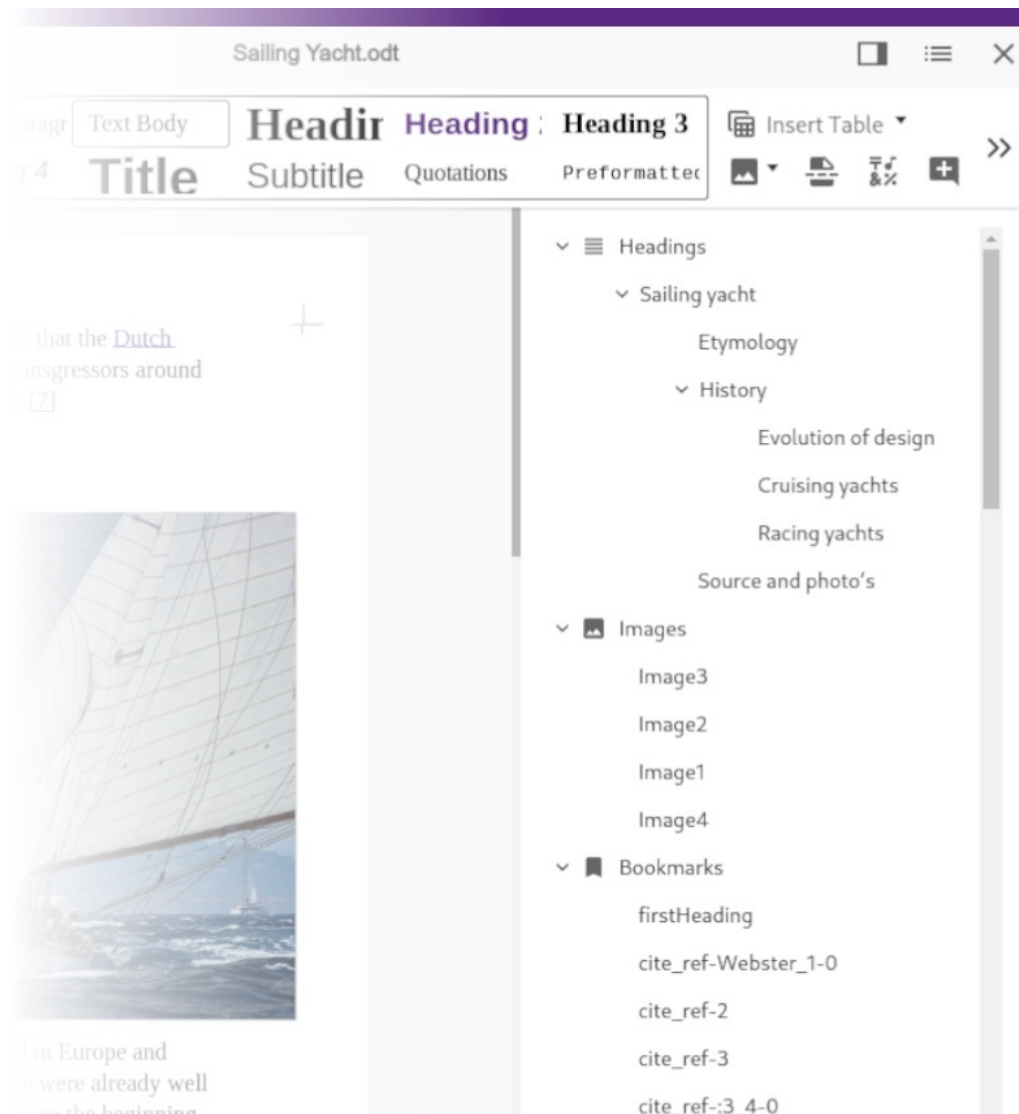

# Interoperability

## Document themes – controlling branding

- Document themes can be configured and applied to a whole document to easily change and re-purpose the appearance, giving it a consistent style and branding.

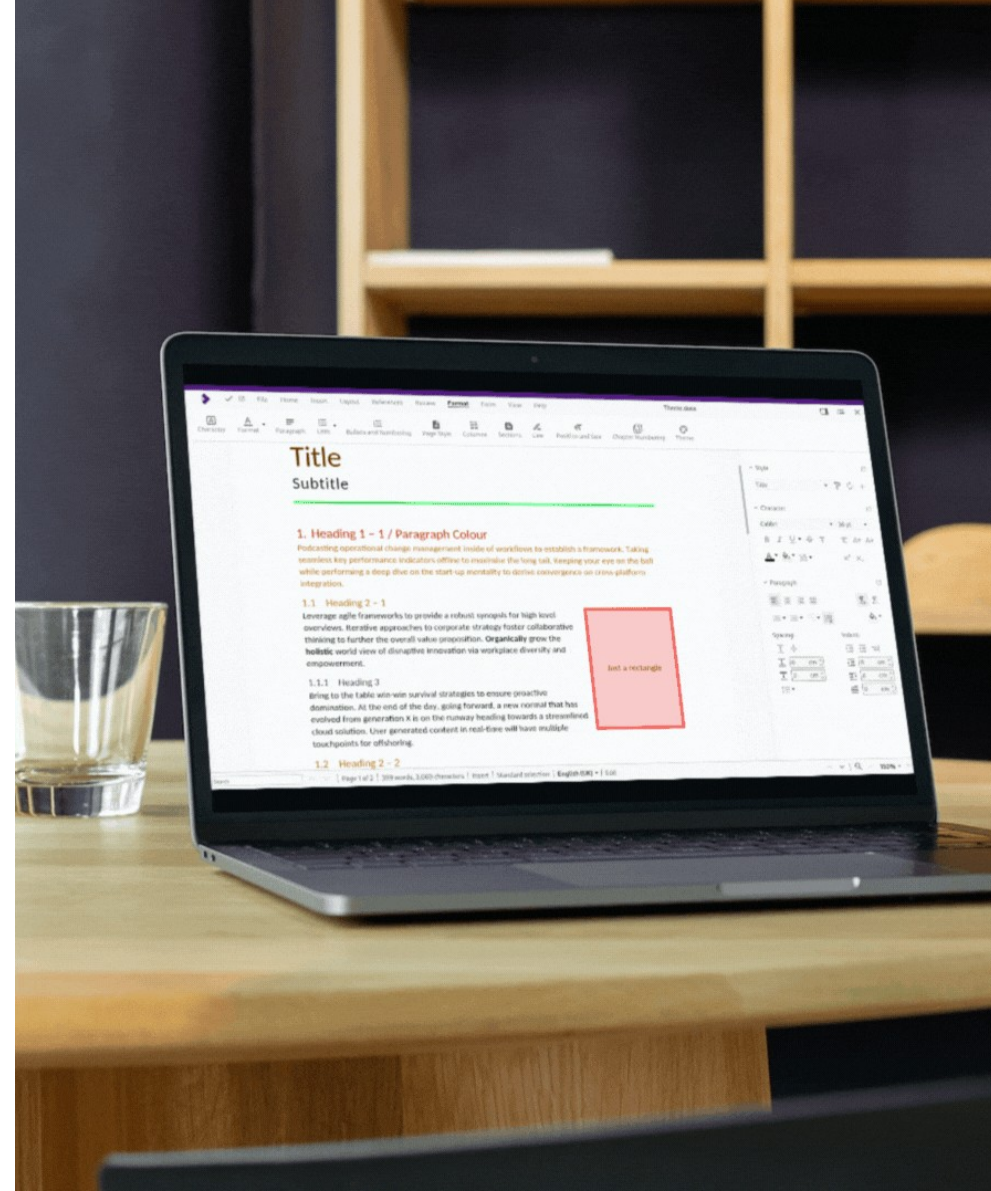



# Interoperability

## Compact Pivot Tables for Calc Spreadsheets

K		L	M	N	O	P
Sum of Val		D				
A	B	C	ddd	ddx	Total Result	
aaa				13	18	31
	bbb			10		10
		ccc		10		10
	bbx			3	9	12
		ccc		3		3
		ccx			9	9
	bxx				9	9
		ccx			9	9
aax				15	11	26
	bbb			10	4	14
		ccc		8	4	12
		ccx		2		2
	bbx			5		5
		ccc		5		5
	bxx				7	7
		ccx			7	7
axx				12	12	24
	bbb				5	5
		ccx			5	5
	bbx			9	7	16
		ccx		9	7	16
	bxx			3		3
		ccc		3		3
Total Result				40	41	81

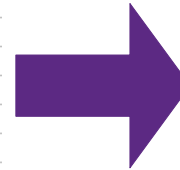

K	L	M	N	
Sum of Val	D			
Row Labels	ddd	ddx	Total Result	
aaa		13	18	31
bbb		10		10
ccc		10		10
bbx		3	9	12
ccc		3		3
ccx			9	9
bxx			9	9
ccx			9	9
aax		15	11	26
bbb		10	4	14
ccc		8	4	12
ccx		2		2
bbx		5		5
ccc		5		5
bxx			7	7
ccx			7	7
axx		12	12	24
bbb			5	5
ccx			5	5
bbx		9	7	16
ccx		9	7	16
bxx		3		3
ccc		3		3
Total Result		40	41	81

# Interoperability

## Multi-page floating tables

- Allows your tables to span content over multiple pages inside floating frames
- Significantly improves interoperability with tables that have been accidentally floated by users, and that span multiple pages.
- Preserving layouts across platforms
  - Lots of mis-designed Government forms – where tables are used for rendering borders are improved, and rendered better.

The screenshot displays the LibreOffice Writer interface with a multi-page floating table. The table is divided into three columns and two rows. The top row contains three columns of text: 'And at this particular moment, just after he pulled off the big time and was making off with the greenbacks.', 'Was there another crook who'd had the same idea, and was now watching him and waiting for a chance to grab the fruit of his labor?', and 'Or did the steps behind him mean that one of many law officers in town was on to'. The bottom row contains three columns: 'He nervously looked all around.', 'Suddenly he saw the alley.', and 'him and just waiting to pounce and snap those?'. To the right of the table, there is a vertical column of text: 'He tried to nervously tap his way along in the inky darkness'. The status bar at the bottom indicates 'Page 2 of 3 | 268 words, 1,398 characters | Insert | Standard selection | English (USA) | Edit'.

And at this particular moment, just after he pulled off the big time and was making off with the greenbacks.	Was there another crook who'd had the same idea, and was now watching him and waiting for a chance to grab the fruit of his labor?	Or did the steps behind him mean that one of many law officers in town was on to
He nervously looked all around.	Suddenly he saw the alley.	him and just waiting to pounce and snap those?

He tried to nervously tap his way along in the inky darkness

and suddenly stiffened: it was a dead-end, he would have to go back the way he had come. The steps

# Usability

## Updated, simplified dialogs

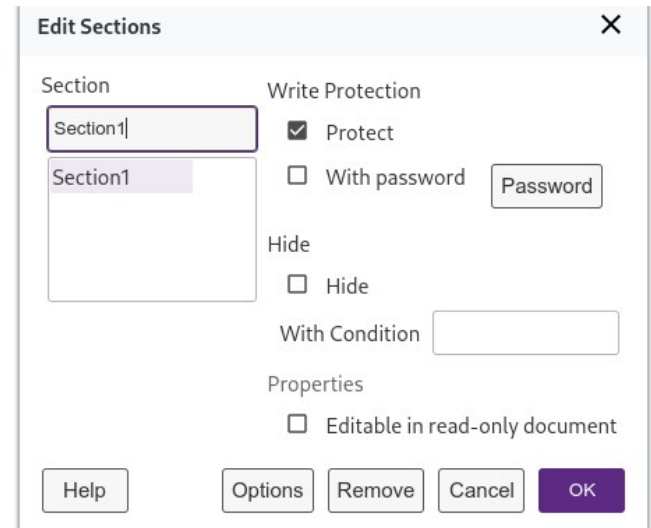
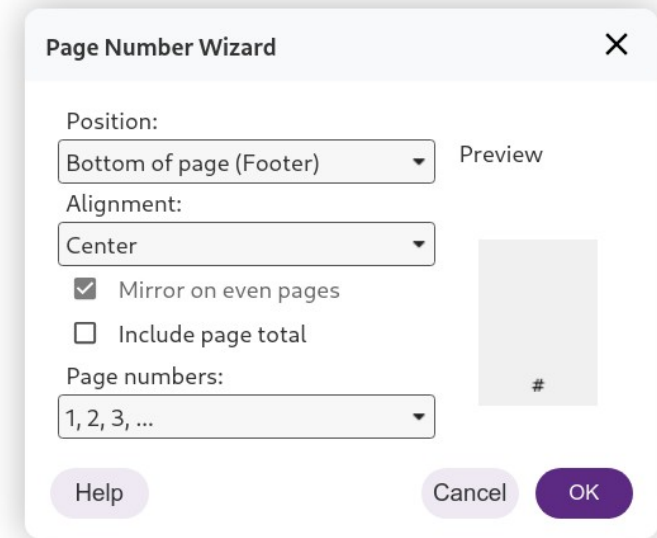
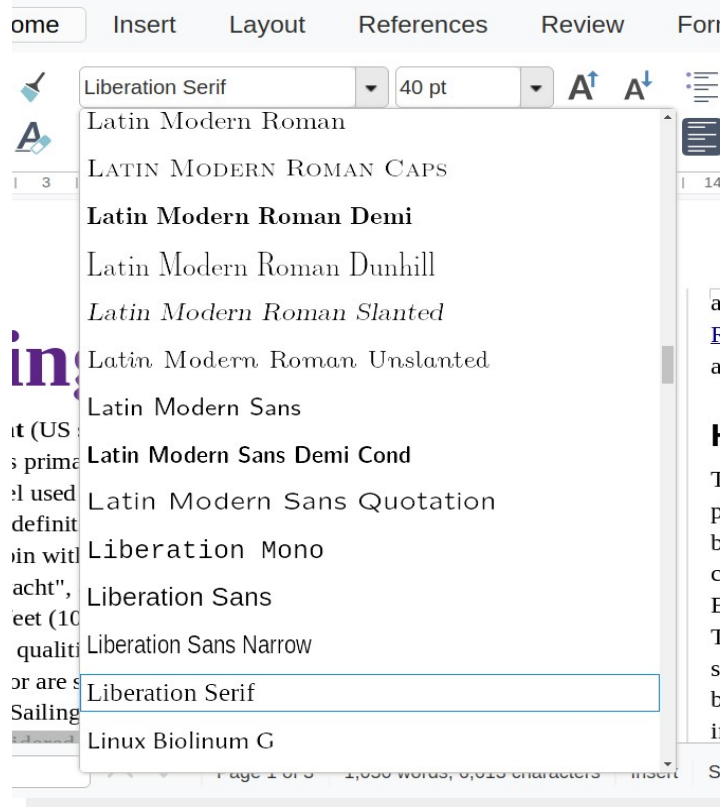

# Async'ing more dialogs ...

## Easy QR Code Generation



**QR and Barcode** ✕

Options

URL/Text:

Error correction:

Low

Medium

Quartile

High

Margin:

Type:

# Usability

## Change tracking in numbered lists

- When making changes within numbered lists, the numbering has now been fixed to show actual and original numbers within the document.

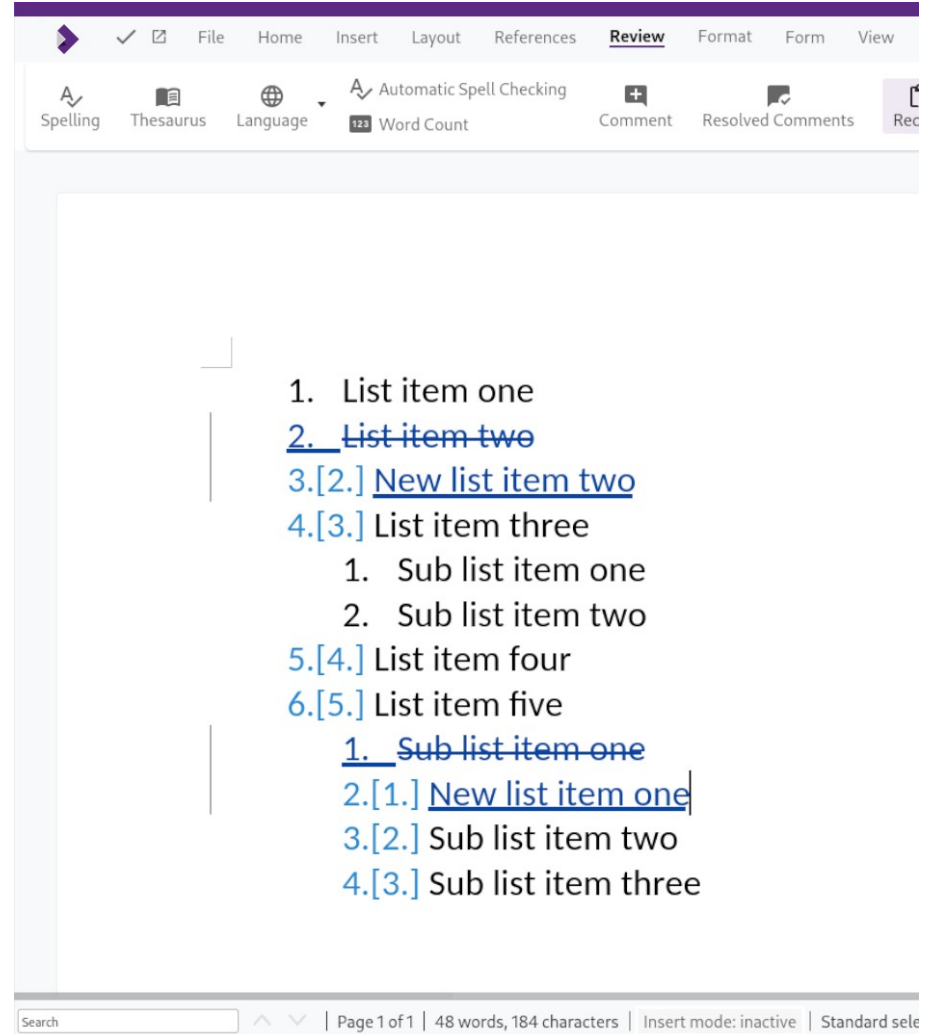

The screenshot displays the LibreOffice Writer interface with the 'Review' tab selected. The ribbon includes options for Spelling, Thesaurus, Language, Automatic Spell Checking, Word Count, Comment, Resolved Comments, and Rec. The main document area shows a numbered list with change tracking. The original list items are shown in blue with a red strikethrough, and the new items are shown in blue with a blue underline. The numbering is updated to reflect the changes.

1. List item one
- ~~2. List item two~~
- 3.[2.] New list item two
- 4.[3.] List item three
  1. Sub list item one
  2. Sub list item two
- 5.[4.] List item four
- 6.[5.] List item five
  1. Sub list item one
  - 2.[1.] New list item one
  - 3.[2.] Sub list item two
  - 4.[3.] Sub list item three

At the bottom of the window, the status bar shows: Search | Page 1 of 1 | 48 words, 184 characters | Insert mode: inactive | Standard sele

# Playground: WASM Prototype:

*(not a product)*

libreoffice - Collabora Collabora | PXGU-696-Offline-in-browser-ed | Online Editor

https://people.internal.collabora.co.uk/~tml/cowasm/cool.html

File Home Insert Layout References Review Format Form View

Karla 12 A A

Paste B I U x<sub>2</sub> x<sup>2</sup> AV

2 | 1 | 1 | 2 | 3 | 4 | 5 | 6 | 7 | 8 | 9 | 10 | 11 | 12 |

Settings

# Network & internet

 **Not connected**  
You aren't connected to any networks [Get Help](#)

 **WiFi**  
Connect, manage known networks, metered network Off

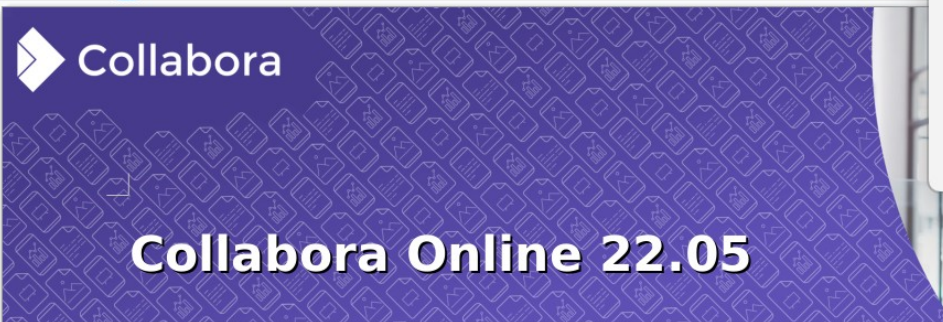

## Collabora Online 22.05

**Collabora Online 22.05: the enterprise-ready LibreOffice-based Online Office Suite that allows you to stay in full control of all your office files.**

LibreOffice is the world's **most popular Open Source Office suite with over 200 million users**. Collabora, a leading contributor to the **project**, and developer of the enterprise-ready, Long Term Supported edition of LibreOffice, Collabora Office, has brought **LibreOffice technology to the cloud**.



# Online Community contributors

- **~100 From the last 12 months - thank you for your contribution!**

Matthaiks, gallegonovato, Sebastiaan Veld, Rob Pearson, Poe Mon, bittin, Martin Srebotnjak, Milo Ivir, Ihor Hordiichuk, Patrick Luby, Oğuz Ersen, Stanislav Horáček, Shavazo, Parth Raiyani, Ayhan Yalçınsoy, Yaron Shahrabani, Leif-Jöran Olsson, Adolfo Jayme Barrientos, Software In Interlingua, genofire, Ali, Alexander Gabilondo, Ettore Atalan, TY Wong, Tucaoever, SC, Besnik Bleta, Andika Triwidada, Cepriř, Rhoslyn Prys, Martin Hoffmann, Julius Härtl, Chase Nelson, Jeff Huang, Hugo B, David D, Darshan Upadhyay, Cosmin Humeniuc, aarsh21, Tron Lee, Sveinn í Felli, Sabri Ünal, Rizal Muttaqin, poi, Nguyễn Hoàng Minh, Navid Sassan, Michael Weghorn, meshari alnaim, m4skedbyte, erbaotao, HB9HIL, Flavio F. M, ButterflyOfFire, Antony, Andi Chandler, Alex Gabilondo, Владимир, Влад, Zeki Tuman, YadlaMani, Tymofii Lytvynenko, Subham Jena, Simon T, shaokuuipo, Seungcheon Seo, Rysertio, rparth07, Qiao Yifeng, NamelessGO, Mowdep, Mohamed Irfan, Miloř Šrámek, Martin Müller, Isy223622, lpwxyz, Louis Chance, Kieli Puoli, k-dasari, Josh, Joan Montané, Jesper Holck, Jérôme Herbinet, iwonder, Héctor Gonzàlvez Escolano, Gabriel Masei, Frankie McEyes, Francisco Gabriel Chardin, DPE, Cyan Ling, CodingwithKetan, CloneWith, ccz, BY, Artur Yakupov, ArshErgon, Areg Nakashian, Alex, Aindriú Mac Giolla Eoin, Allkiv



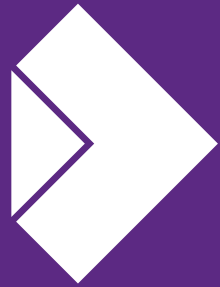

# Collabora Online

*Oh, that my words were recorded, that they were written on a scroll, that they were inscribed with an iron tool on lead, or engraved in rock for ever! I know that my Redeemer lives, and that in the end he will stand upon the earth. And though this body has been destroyed yet in my flesh I will see God, I myself will see him, with my own eyes - I and not another. How my heart yearns within me. - Job 19: 23-27*

# Thank you!



**@CollaboraOffice**  
**hello@collaboraoffice.com**  
**www.collaboraoffice.com**